



A Plan for the Use & Management
of the

OSLO RIVERFRONT CONSERVATION AREA

Amended to include the Flinn Tract

Indian River County/
St. Johns River Water Management District
1995
Updated 2009

Indian River County
Environmental Planning Section
February 14, 1995¹
_____, 2009²

¹ This management plan received conceptual approval by the Board of County Commissioners on April 27, 1993, and was subsequently approved in 1995 by the St. Johns River Water Management District.

² The update of this management plan received conceptual approval by the Board of County Commissioners on _____, 2009, and was subsequently approved in 2009 by the St. Johns River Water Management District and the Florida Inland Navigation District.

TABLE OF CONTENTS

INTRODUCTION.....	1
Land Management Goals	
CONSERVATION AREA OVERVIEW.....	3
Regional Significance	
Location Map	
Vicinity Map	
Acquisition History	
Land Use Designation	
NATURAL AND CULTURAL RESOURCES OVERVIEW.....	6
Topography and Hydrology	
Soils	
Natural Communities Map	
Natural Communities and Wildlife	
Cultural Resources	
PAST MANAGEMENT SUMMARY.....	12
Mosquito Impoundment Management	
Exotic Plant Removal and Control	
IMPLEMENTATION.....	13
RESOURCE PROTECTION AND MANAGEMENT	
Security	
Water Resource Protection and Wetland Restoration	
Upland Restoration	
Exotic Species	
Cultural Resource Protection	
LAND USE MANAGEMENT	
Access, Recreation and Outreach	
Conceptual Development Plan	
Development Costs	
ADMINISTRATION	
Acquisition	
Cooperative Agreements, Leases, Easements and Special Use Authorizations	
Revenue Generation	
IMPLEMENTATION CHART.....	19
FIGURES	
Figure 1 – Location Map	4
Figure 2 – Vicinity Map	5
Figure 3 – Natural Communities Map.....	9
Figure 4 – Conceptual Development Plan.....	17

INTRODUCTION

The Oslo Riverfront Conservation Area (ORCA) consists of two parcels of land. The original "**OSLO RIVERFRONT**" **PROPERTY** is approximately 298 acres of undeveloped mature coastal hammock, scrubby flatwoods, and impounded estuarine wetlands located on the north side of Oslo Road adjacent to the Indian River Lagoon in Indian River County. The property has approximately 568 feet of frontage on Oslo Road (9th Street S.E.), and is located just east of the South Vero Square Shopping Plaza on the northeast corner of U.S. Highway #1 and Oslo Road. The property is north of and surrounds the Florida Medical Entomology Laboratory property. The property includes over two miles of Indian River Lagoon shoreline, and encompasses a lagoon cove known as "Crawford Notch". (See Figures 1 and 2.) The original parcel is owned by Indian River County and the St. Johns River Water Management District.

The St. Johns River Water Management District is an agency of the State of Florida, one of five regional water management districts with the responsibility to preserve and manage Florida's water resources. Part of that responsibility is the acquisition and management of lands important to the preservation of wetlands and other water resources.

On August 21, 1991, Indian River County (hereinafter referred to as the County) and the St. Johns River Water Management District (hereinafter referred to as the District) purchased the Oslo Riverfront property, with each party acquiring an undivided one-half interest. In sharing the cost of the public acquisition, it was agreed by both parties that the District and the County would coordinate on the approval of the property's management plan, but that Indian River County alone would be responsible for the management and maintenance of any recreational areas and facilities established on the property.

Subsequently, the County entered into an Intergovernmental Management Agreement with the District for a thirty (30) year period, commencing on November 5, 1991 and terminating on November 4, 2021. The Oslo Riverfront property is now known as the Oslo Riverfront Conservation Area, hereinafter referred to as ORCA. The Management Agreement provides that "the function and condition of the Oslo Riverfront property with respect to water management, water supply and the conservation and protection of water resources will be maintained or enhanced and the property will be managed to control the growth of non-native invasive plant species". The Management Agreement also provides that "recreational activities planned or conducted within the wetlands and other naturally vegetated areas shall be resource-based and the development of recreational facilities within the wetlands restricted to trails, boardwalks, or other alterations which facilitates access for the passive/non-consumptive recreational user".

In 1998, the Flinn Tract addition was acquired by the County and the District, with the additional participation of the Florida Inland Navigation District. The Florida Inland Navigation District (FIND) is the "local sponsor" for the Atlantic Intracoastal Waterway (ICW), a navigation project funded through state and federal programs. The FIND manages the ICW in the Indian River Lagoon immediately to the east of the managed property. As part of its responsibility for the ICW, the FIND also administers dredged material management sites. The FIND identifies and obtains applicable permitting for such sites.

The Flinn Tract is a 37.6-acre parcel of mature coastal hammock and mosquito impoundment located about 0.75 mile north of the northern boundary of the original ORCA parcel. The tract extends from the right of way of Indian River Boulevard eastward to the shoreline of the Indian River Lagoon, and includes a portion of the Vista Gardens #20 mosquito impoundment managed by the Indian River Mosquito Control District. River Park Place, a residential development abuts the Flinn Tract to the south. FIND property acquired for dredged material management is located along the northern boundary of the Flinn Tract. Ownership of the Flinn tract is held by the County, the District and FIND as undivided interests in the ratio of 50%, 25% and 25%, respectively.

The Oslo Riverfront Conservation Area Intergovernmental Management Agreement was amended on May 12, 1999 to include the Flinn Tract and to add FIND as a party to the agreement. The amendment establishes that the County will assume primary management responsibility for the Flinn property for maintenance of the entrance roadway, day to day maintenance and security, removal of invasive terrestrial and aquatic plant species, and provision of public recreational opportunities. The District will assist with land management activities as requested by the County, subject to the availability of funds. FIND will, subject to the availability of funds, assist the County with funding for invasive vegetation management and for the development of public recreational opportunities.

Representatives from the District, County Planning and Engineering Divisions, FIND, the Florida Medical Entomology Laboratory (FMEL), the Florida Native Plant Society (Eugenia Chapter), the Indian River Mosquito Control District (IRMCD), the Environmental Learning Center and the Indian River Land Trust have been consulted in the formulation of this management plan. This land management plan replaces the 1995 ORCA management plan and will be updated in 2014.

LAND MANAGEMENT GOALS

The goals of public ownership of the Oslo Riverfront Conservation Area are:

1. To maintain and enhance the condition of the property with respect to water supply, quality and management.
2. To remove and control the growth of invasive plant species.
3. To manage the natural and cultural resources of the property for their long-term preservation and enhancement.
4. To provide passive resource based outdoor recreational opportunities and the facilities needed to support public access.
5. To coordinate the management of the Conservation Area between the various parties involved in its management, including the District, the County, ORCA volunteers, the Indian River County Mosquito Control District and FIND.
6. To support the efforts of the Indian River Land Trust to create a network of shared use trails for public access to the Indian River Lagoon north of the South Relief Canal with the Flinn Tract serving as the public access parcel.

The purpose of this plan is to guide the future use and management of the ORCA. The plan begins with a synopsis of the significance, history, water management functions and natural and cultural resources of the property. A summary of past management activities and an outline of future resource management programs are provided and a conceptual plan for the addition of compatible recreational

activities and other appropriate land uses is established.

CONSERVATION AREA OVERVIEW

Regional Significance

The Indian River Lagoon adjacent to the ORCA property is part of the Vero Beach to Fort Pierce State Aquatic Preserve (No. A-9), and has also been deemed an Estuary of National Significance by the federal government. The Indian River Lagoon is also a Surface Water Improvement and Management (SWIM) priority waterbody designated by the State of Florida. The ORCA project is one of a number of conservation areas established by Indian River County in partnership with the District and with the Florida Communities Trust to protect parcels of developable land along the Indian River Lagoon from future residential or commercial development. County staff with the Environmental Planning Section, the Parks and Recreation Division and the Indian River Mosquito Control District have implemented management programs on each of these conservation areas to eradicate or control invasive exotic plant species, enhance the treatment and control of stormwater runoff entering the lagoon, and to enhance the Rotational Impoundment Method (RIM) management programs of mosquito impoundments at several locations. These conservation areas and management programs are important elements of the collaborative effort by federal, state, local government agencies and local volunteer groups to protect, enhance and restore the important ecological attributes of the Indian River Lagoon.

In 2007, a local citizens group and the Indian River Land Trust, which owns approximately 66 acres of land between the original ORCA property and the Flinn Tract, established the idea for an Indian River Lagoon Greenway between the South Relief Canal and the 17th Street Bridge. Working with the citizens group (now the Lagoon Greenway Advisory Committee) together with staff from the Mosquito Control District, the Florida Inland Navigation District, and the Indian River County Environmental Lands Program, the Indian River Land Trust has developed a plan for the Indian River Lagoon Greenway, which is included in the Appendix of this plan.

LOCATION MAP



FIGURE 1

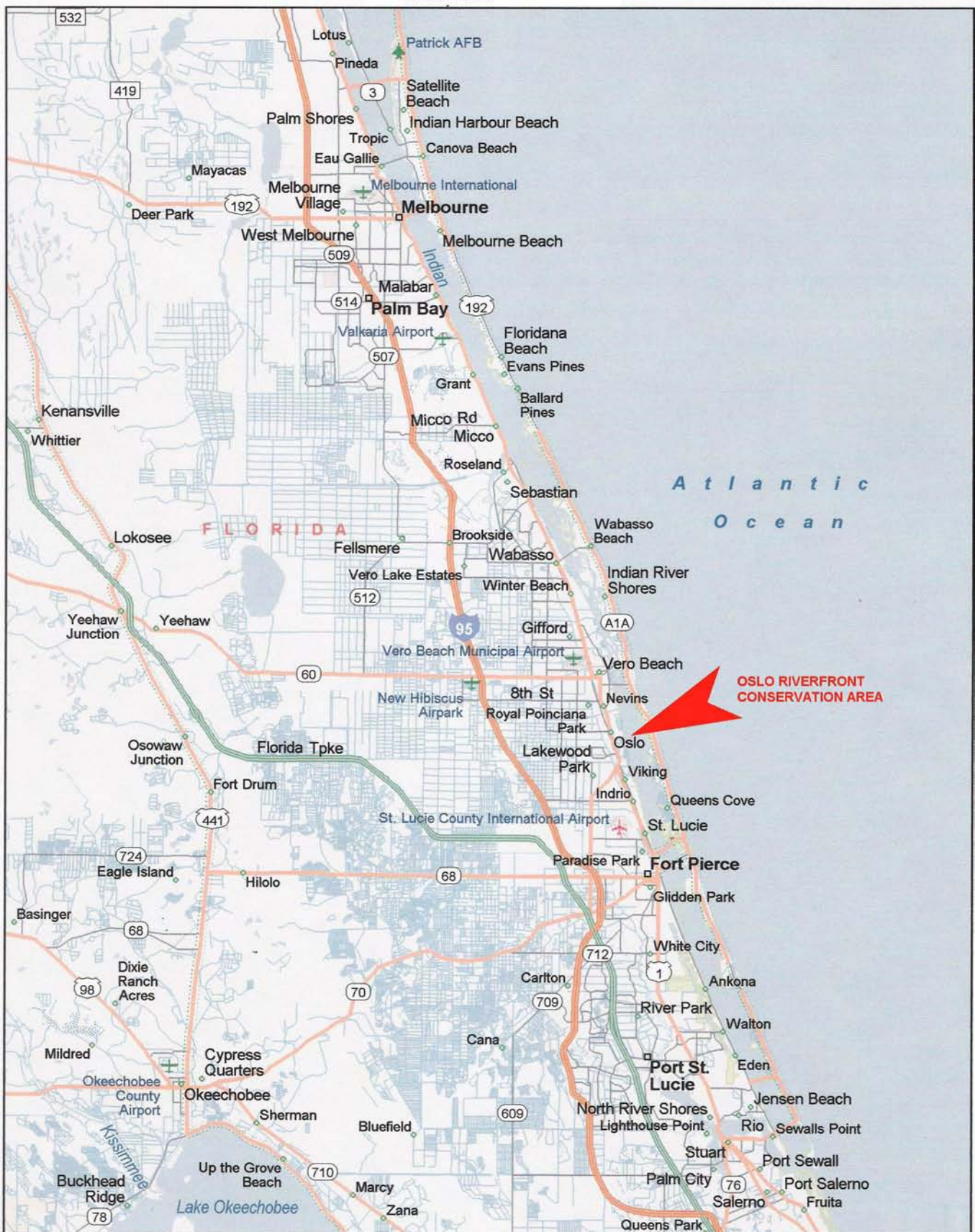

**OSLO RIVERFRONT
CONSERVATION AREA**

**FIGURE 2
PAGE 5**



The goals for the Lagoon Greenway include creation of a continuous set of pathways for non-motorized use through the upland and lowland areas along the Indian River Lagoon, provision of a diversity of recreational and educational opportunities within the Greenway Planning Area for the residents and visitors of Indian River County, continuation of the protection and conservation of the natural resources of the Lagoon and adjoining wetland and upland habitats and development of interpretive facilities (and corresponding programs) to educate the public on the significance of the Greenway's natural and cultural resources and the need for their management.

Acquisition History

In May 1990, United Financial Group, Inc., owner of the ±300 acre original ORCA property at that time, unsuccessfully requested that 65 acres of the property (mature coastal hammock) be rezoned from RS-1, Single-family Residential, 1 unit per acre, to RM-10, Multi-family Residential, and 10 units per acre density. United Financial Group's request was denied by the Board of County Commissioners, which cited traffic and utilities "Level of Service" (LOS) concerns. Subsequently, in August, 1991, the property was acquired jointly by Indian River County and the St. Johns River Water Management District for \$1,860,000, for purposes of resource conservation and enhancement. The Flinn Tract was acquired jointly by the County, the District and FIND in October 1997 for a total cost of \$1,353,550 from Robert and Richard Flinn. The parcel was evaluated as the key parcel in the County's Indian River Boulevard South initiative, since non-fee simple protection methods were being used to protect 6 of the 7 other ownerships in that overall project. The Flinn Tract was the only parcel that contained intact maritime hammock east of the boulevard. Its acquisition also provided opportunities to work with the Indian River County Mosquito Control District to enhance the RIM program within the mosquito impoundment, and to collaborate with FIND for an integrated management regime addressing both the Flinn Tract and FIND's dredged material management site immediately adjacent to the north.

Land Use Designations

The Future Land Use Element of the Indian River County Comprehensive Plan designates the Conservation Area, including the Flinn Tract addition, as C-1 Conservation, and the property is zoned as Con-1, Public Lands Conservation District.

NATURAL AND CULTURAL RESOURCES OVERVIEW

Topography and Hydrology

The history of mosquito impoundment to reduce mosquito populations along the Indian River has produced significant effects on the topography and hydrology of the estuarine shoreline. In the 1950s and 1960s, salt marshes and mangrove swamps associated with the Indian River Lagoon were "impounded" for mosquito control purposes. A mosquito control impoundment is a marsh or mangrove swamp which has been partially or totally enclosed with an earthen dike. An impoundment allows a marsh (wetland) to be flooded during mosquito egg-laying season. This seasonal flooding substantially controls mosquito production, because mosquitoes will not lay their eggs on standing water. Although impounding wetlands proved to be an effective method of mosquito control, the practice disconnected wetland habitat from the lagoon estuary, to the detriment of estuarine species. In recent years, efforts have been made to "re-connect" these impoundments to the lagoon via culverts with flap-gates, which improves habitat while still affording seasonal flood control. Ditching and the construction of

impoundment dikes have altered the natural shallow-sloping topography of the mangrove swamp, and diverted sheet flow drainage patterns. West of the impoundment areas, naturally flat topography is disrupted in a few locations by the construction of roads, jeep trails and drainage ditches, but remains generally intact.

The original ORCA project area contains two impounded estuarine wetlands: "South Vista Royale" (Impoundment #18) and a portion of "North ORCA" (Impoundment #19). The South Vista Royale impoundment is approximately 133 acres. Construction of the impoundment occurred in 1958 and 1963. Management of the impoundment has consisted of seasonal flooding during spring and summer since 1958 via the use of a 6,000 gpm manually operated diesel pump. In the mid 1990s, the Indian River Mosquito Control District, using Surface Water Improvement and Management (SWIM) funds, re-connected the impounded wetlands to the Indian River by installing culverts with flap-gates for rotational impoundment management (RIM).

The North ORCA impoundment is approximately 52 acres in size and was impounded in 1957. Management of the impoundment from 1957 to 1976 consisted of seasonal flooding during the spring and summer by use of a manual pump. RIM management of the impoundment has now been improved with the installation of culverts.

The original ORCA property contains approximately 233 acres of wetlands, ± 185 of which are impounded for mosquito control purposes. The Flinn Tract adds an additional ± 18 acres of wetland habitat, approximately 15 acres of which is impounded. The SJRWMD Indian River Lagoon Basin Land Acquisition Study (Gurr et al., 1990) characterizes the property as "located in the Indian River Lagoon Sub-basin III.D draining directly into the Indian River Lagoon between Sebastian Inlet and Fort Pierce Inlet". An FDOT drainage ditch flows through the original property from U.S. 1 to the Indian River. On the Flinn Tract, an FDOT drainage ditch conveys runoff from Indian River Boulevard to the ditch surrounding the impoundment. According to the Gurr study, the subject property has approximately 500 acres of off-site contributory drainage, and this drainage is conveyed through the wetlands portions of the site by a series of ditches and channels. Sheet flow drainage through the uplands portion of the site is intercepted by a ditch and brought into the wetlands.

A portion of the upland area of the original project area (approximately ± 15 acres) is scrubby flatwoods with moderately well drained soils, allowing for good percolation of rainfall and direct recharge of the Surficial Aquifer. Groundwater recharge occurs in the maritime hammock communities on the original tract and on the upland portion of the Flinn Tract, although the soils in the maritime hammock community are less well drained than the scrubby flatwoods soils on the original parcel.

SOILS

The Soil Survey of Indian River County (USDA SCS, 1987) depicts four soil types on the ORCA property, summarized as follows:

<u>Soil Type</u>	<u>Drainage Characteristics</u>	<u>Associated Plant Community</u>
Mckee mucky clay loam	very poorly drained	estuarine wetland
Myakka fine sand	poorly drained depressions	mesic flatwoods
Pomello sand well drained	moderately	scrubby flatwoods
Jupiter fine sand	poorly drained	coastal hammock

Natural Communities and Wildlife

The ORCA property natural communities consist of four main categories, with small areas classified as ruderal land (designated AP or R), as follows. (See Figure 3, Natural Communities Map):

<u>Community Type</u>	Approximate Acres	
	<u>Original Tract</u>	<u>Flinn Tract</u>
Coastal/Tropical Hammock	38	14
Scrubby Flatwoods	15	0
Fresh Water Transitional Wetlands	1	3
Estuarine Wetlands (Mosquito Impoundment and Mangrove Swamp)	233	15
Ruderal	<u>11</u>	<u>6</u>
	298	38
Total ORCA acreage = 336 acres		



LEGEND

- NATURAL COMMUNITIES
- MH MARITIME HAMMOCK
- SF SCRUBBY FLATWOODS
- MS MANGROVE SWAMP
- MI MOSQUITO IMPOUNDMENT
- TW TRANSITIONAL WETLANDS
- AP AUSTRALIAN PINE
- R RUDERAL
- ORCA BOUNDARY
- FIND BOUNDARY
- INDIAN RIVER LAND TRUST BOUNDARY

OSLO RIVERFRONT
CONSERVATION AREA
FLINN TRACT UPDATE

NATURAL COMMUNITIES MAP
APRIL, 2009
FIGURE 3 PAGE 9

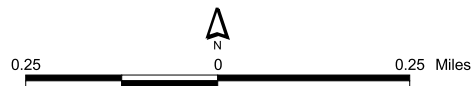

The local Eugenia Chapter of the Florida Native Plant Society conducted a plant inventory of the original ORCA property, and the list has been maintained and updated by volunteers and staff from the Florida Medical Entomological Laboratory (FMEL). A list of plants and animals, also contributed by ORCA volunteers, is included in the appendix of this plan. Approximately 20 rare plant species have been identified on site, including Simpson's Stopper (*Myrcianthes fragrans simpsonii*), Coral-Root Orchid (*Corallorrhiza wisteriana*), and Whisk Fern (*Psilotum nudum*). Although a similar plant survey has not been conducted on the Flinn Tract, the maritime hammock community there has the potential to support the same species of plants, including the listed species noted on the original property. A natural resources inventory of the upland portion of the Flinn Tract will be conducted prior to design of trails and other related facilities.

Wildlife found on the ORCA property is typical of the shoreline wetlands and uplands of the Indian River Lagoon. Listed species found in or occasionally visiting the conservation area and the adjacent nearshore areas include West Indian manatee, Gopher tortoise, Roseate Spoonbill, Great Egret, Little Blue Heron, Reddish Egret, Snowy Egret, Tricolored Heron, White Ibis, Merlin, American Oystercatcher, Wood Stork, Osprey, Brown Pelican, Black Skimmer, American Redstart, Least Tern and Royal Tern. An effort to compile a more complete animal list by the volunteers of the conservation area is currently underway. The following common animal species are likely to occur on the ORCA property, based on animal surveys conducted on similar locations elsewhere on the Indian River Lagoon: Eastern Cottontail, Marsh Rabbit, Raccoon, Opossum, Eastern Mole, Gray Squirrel, Gray Fox and Bobcat.

Tropical Maritime Hammock

Maritime hammock community is located in two stands on the original ORCA tract, totaling approximately 38 acres. Although this community was heavily damaged during the 2004 hurricane season, with many large oak and pine trees downed (including a former champion slash pine) the community is in generally good condition. Nuisance exotic Brazilian pepper (*Schinus terebinthifolius*) existed on the southwest corner of the property near Oslo Road and the South Vero Square shopping plaza when the property was acquired. These invasive exotic plants were removed by 1998. Exotic plant infestations, primarily Brazilian pepper and air potato (*Dioscorea bulbifera*), have been the focus of removal efforts by County staff and volunteers on a semi-regular basis since 1991. Two stands of Australian pines remain along the northwestern property line, as noted on the natural communities map.

The maritime hammock community on the Flinn Tract totals approximately 14 acres. Three stands of Australian pines are located at the edges of the community, as noted on the natural communities map. Australian pines and other exotic species were removed from approximately 8 acres of the hammock and transitional wetland communities in 2006 and 2007 as part of an upland and forested wetland mitigation project. That area is now under an annual maintenance program pursuant to the mitigation permit requirements.

Scrubby Flatwoods

The scrubby flatwoods community on the ORCA property consists of one stand approximately 15 acres in size. It is located in the southwestern portion of the site, bounded on the east and west by hammock community. This fire-dependent community is in the process of succeeding to hammock conditions due to fire exclusion over a long period of time. The community is therefore evaluated as being in a fair condition. Aside for the need for prescribed fire, the primary management action required of the flatwoods community is the ongoing removal and control of invasive exotic plants.

Mangrove Swamp

In total, approximately 55 acres of the original estuarine wetland community are intact at ORCA. It is located waterward of the mosquito impoundment berms where tidal flushing has not been impeded by the construction of the impounded areas. This community was the most heavily impacted of all the conservation area's plant communities when mosquito impoundments totaling nearly 250 acres were constructed in the 1950's and 1960's. Management needs of the mangrove community include control of encroaching invasive exotic plants and protection from damage for boat wakes and maintenance activities on the adjacent impoundment dikes. Wildlife associated with the mangrove community include the wading birds and shorebirds typical of the Indian River Lagoon, and the small fry of the Lagoon's fishery, including snook, redfish and many other popular game fish.

Mosquito Impoundment

The largest vegetative associations on the ORCA property are the mosquito impoundments. These areas were formerly high salt marsh and mangrove communities, and, due to Rotational Impoundment Management, now function somewhat as they did prior to ditching and diking for mosquito control. In addition to mangrove species, the impoundments are vegetated with a mix of salt-tolerant plants, including saltwort, glasswort, salt grass, sedges and sea ox-eye, and are generally in good condition. Management needs include continuous maintenance of water control structures and pumps, and the removal of encroaching invasive exotic plants. Near monocultures of Brazilian pepper with associated exotic plants is a continuing problem on the dikes surrounding the impoundments. Trimming to preserve maintenance access, occasional exotic plant removal projects and maintenance of the infrastructure (pumps, culverts and dikes) of the mosquito impoundments are the responsibility of the Mosquito Control District.

Transitional Wetlands

Three to four acres of this classification are located at ORCA, the majority lying between the maritime hammock and the impoundment ditch on the Flinn Tract. That area was the subject of the upland and forested wetland mitigation project discussed above. It is now in poor condition as the restoration process continues. Planting of native wetland plant species and the continued management and control of exotic plant species are needed to restore this area to more natural condition and function.

Cultural Resources

A 1992 county-wide archaeological survey funded by Indian River County and the State Division of Historical Resources, conducted by The Archaeological and Historical Conservancy, Inc., identifies three intact archaeological sites on the property and the adjacent IFAS Florida Medical Entomology Laboratory property.

The three sites located on or adjacent to the original ORCA property are on the Florida Master Site File for archaeological resources. The sites have been named the Bidlingmayer Site (#8-IR-836), located on County-owned property south of Oslo Road, the IFAS (Institute of Food and Agricultural Sciences) Site (#8-IR-837), located on FMEL property, and the Crawford Site (#8-IR-838), located on the original ORCA property.

Together, the sites are part of a large ceramic and oyster shell midden complex, including animal (e.g., bird, fish, and turtle bone) remnants. The sites are suspected to be indicative of an Ais Indian summer village site, opposite an Ais winter village site on the barrier island. The Archaeological and Historical Conservancy, Inc. concludes that the sites are significant, describing the IFAS Site as "extremely important: not only does it contain information about [Ais] resource exploitation of the estuary back lands, but also enough non-faunal material to provide information about intra-regional trade and cultural influences".

No known archaeological sites are located on the Flinn Tract. A lithic scatter site is listed just offshore from the FIND property, to the northeast of the ORCA boundary.

PAST MANAGEMENT PRACTICES

Mosquito Impoundment Management

In 1994 and 1995, the Indian River Mosquito Control District (IRMCD) implemented improvements to reconnect the South Vista Royale Impoundment to the Indian River Lagoon via the installation of nine 30" diameter culverts. The management method, known as rotational impoundment management (RIM) uses culverts equipped with flap-gates to allow for controlled seasonal flooding.

Under the RIM plan, the southeast impoundment cell (+40 acres) was connected to the lagoon via two 30" culverts. As a result, the cell is now intertidal year-round. The southeast impoundment cell may be flooded in summer months, however, but only as necessary in certain years when mosquito production becomes problematic. The culvert opening and closing schedule for the remainder of the impoundment is consistent with other RIM plans for this portion of the lagoon. Culvert closing is in the late spring or early summer, depending on rainfall patterns. The impoundment is flooded to a maximum of 1.8 ft. NGVD, which is the minimal flood level necessary to cover much of the marsh surface. Culverts are opened in the late summer or early fall of each year, which is when rising lagoon levels historically flood high marshes. The restoration project has improved the wetlands and benefited the Indian River Lagoon by reintroducing important nursery and feeding grounds to lagoon marine life. The controlled seasonal flooding also reduces the need of pesticide use for mosquito control purposes.

Indian River Impoundment #19 (North ORCA) is also managed under a Rotational Impoundment Management (RIM) scenario. It has 5 culverts which are closed in the Spring, typically in late April or early May. Water from the Lagoon is pumped to flood the impoundment and keep it at flood level until October, typically, when the Fall high tides occur. The IRCMD then opens the culverts to allow for a free exchange of water and organisms between the impoundment and Indian River Lagoon until the next spring, when the 5 culverts are again closed and the process is repeated.

Exotic Plant Removal and Control

A Brazilian pepper stand on the southwest corner of the original property near Oslo Road and South Vero Square Plaza was removed shortly after acquisition with the use of County mitigation funds. The trailhead parking area was located in this area. Elsewhere on the original property, Brazilian pepper is largely confined to areas along the mosquito impoundment dike. Brazilian peppers interspersed within native plant community areas are treated with herbicide and left to deteriorate in place. Other areas with Brazilian peppers, along impoundment dikes and canals, have periodically been mechanically removed by IRCMD staff and/or County work crews. Periodically, County staff and ORCA volunteers conduct exotic removal projects throughout the property, focusing on infestations of Brazilian pepper, air potato and other Category I and II exotic plant species, listed by the Florida Exotic Pest Plant Council (FL EPPC).

An exotic plant removal project was implemented on the Flinn Tract in 2006 and 2007, clearing approximately eight acres of Brazilian pepper from transitional wetlands and maritime hammock communities. The project was a wetland impact mitigation permitted by the SJRWMD, and is now under regular monitoring by Bio-Tech Consulting, Inc. Monitoring will extend until 2010 or until the mitigation success criteria have been met. Specific activities included hand clearing and herbicide application of the exotic plants. The project was originally designed to remove only Brazilian pepper, but other invasives have been treated as well.

IMPLEMENTATION

RESOURCE PROTECTION AND MANAGEMENT

Security

ORCA is open to the public from sunrise to sunset. The property boundary is partially fenced at this time. Where security problems and encroachment from adjacent land is a problem, fencing will be installed. Approximately 3,400 feet of fencing to address the encroachment issue is needed along the boundary between the original property and the adjacent residential community to the west (see Conceptual Development Plan). Security for the property is provided by the Indian River County Sheriff's Office.

Water Resource Protection and Wetland Restoration

The Indian River Mosquito Control District is responsible for ongoing maintenance and management of the mosquito impoundments on the ORCA property. The management plans for the impoundments are included in the Appendix of this plan. County staff will continue to work with the Mosquito Control District to manage mosquito control and wetland function in the impoundments.

County staff will continue to work with adjacent land owners and the Florida Department of Transportation to protect and improve water quality entering the ORCA property. Stormwater management improvements by FDOT will be considered during future reconstruction projects on US 1, since drainage from the state road is currently channeled through the ORCA property to the Indian River Lagoon.

Additional wetland mitigation projects will be considered on a case-by-case basis by County staff, subject to written approval by District land management staff, and with FIND staff when project areas on the Flinn Tract are involved. Wetland impacts from the FIND construction of a dredge material management area on the FIND property located north of the Flinn Tract will be implemented on the Flinn Tract. Details of that mitigation project are not available at this time. FIND will coordinate the project with the County and the SJRWMD during the design and permitting phase of the dredge material management area.

In cases where the County, SJRWMD and FIND agree to allow private wetland mitigation in the conservation area, the private mitigator will be responsible for annual reporting to permitting agencies and for follow-up treatments and plantings to satisfy permitting agencies' requirements, for a minimum of five years.

Upland Restoration

Maritime Hammock

The coastal maritime hammock of ORCA is at a climax, mature stage of growth. Some of the large live oaks dominating the canopy of the hammock are hundreds of years old, and are capable of living for many years to come. Native groundcover is an important ingredient of a pristine hammock, and public access of the hammock will continue to be controlled with well defined trails, to discourage pedestrian disturbance of herbaceous plants off the designated trails.

The principal management need of this community consists of the continued suppression of nuisance exotic plant invasion. County staff will continue to coordinate efforts of volunteers and service groups to identify, remove and retreat problem areas of infestation.

Scrubby Flatwoods

Scrubby flatwoods share characteristics of xeric sand pine or oak scrub and pine flatwoods. Understory plant species are similar to sand pine scrub, but scrubby flatwoods generally have greater species diversity. Scrubby flatwoods are distinguished from pine flatwoods, which are commonly associated with more poorly drained soils. Scrubby flatwoods are considered a fire-based community, and naturally occurring fires play an important role in their regeneration and maintenance. Although scrubby flatwoods historically burn every 8 to 12 years, the scrubby flatwoods at the Oslo Riverfront Conservation Area have not been burned in many years. Exclusion of fire from scrubby flatwoods eventually results in succession (as in this case) towards xeric hammock community.

Prescribed fire management of this community in the ORCA is not considered to be a feasible management action, due to the location of the community in close proximity to residential development, the major highway to the west, and to the FMEL facility on Oslo Road. Fire management is further complicated by a lack of suitable access routes for the equipment necessary to conduct prescribed burning. Given the small extent of the community, County staff have determined that prescribed burning will not be a management action here in the future, so that the County's prescribed fire efforts can be focused on fire dependent communities located south of Oslo Road and on other conservation areas managed by Indian River County. Since the community is ranked S3 (rare or uncommon within the state) by the Florida Natural Areas Inventory, restoration should be the long-term goal for its management. Restoration of the community by continued removal and control of exotic plants and mechanical/chemical restoration efforts by roller-chopping and herbicide treatment will be implemented when funding or mitigation opportunities become available.

Exotic Species

Removal, management and control of FL EPPC Category I and II invasive exotic plant species, including Brazilian pepper, air potato vine and Australian pine has been the primary management activity at ORCA since the original acquisition in 1991. Given the large invasive plant seed sources surrounding the conservation area, eradication of exotics will not be possible, but management control is feasible. The control of these invasive species requires a long-term commitment of labor resources, which will depend on volunteer support from the local community.

Over the next five years, County staff will direct upland mitigation funds to the ORCA project when possible, and will seek additional funding from the Bureau of Invasive Plant Management of the Florida Fish and Wildlife Conservation Commission. Priority areas for future exotic species removal are the remaining stands of Australian pines along the property boundary in the southwestern portion of the original ORCA property, and the three remaining stands located on the Flinn Tract. County staff will continue coordination with the IRCMCD for continued control and removal of Brazilian peppers associated with the mosquito impoundment dikes. Planting of native species appropriate to the original natural community or to existing elevation and hydrological conditions of each site will follow removal of large stands of exotic plants, as appropriate.

Cultural Resource Protection

The archaeological sites on the ORCA property are relatively intact. Two potential threats to these sites are disturbance associated with construction of recreation access and scavenging by amateur archaeology enthusiasts. For these reasons, existing recreational improvements on the have been carefully located so as not to result in construction disturbance of the archaeological sites, and located so as not to promote easy public access to the sites for unauthorized scavenging. On the Flinn Tract, reconnaissance-level archaeological surveying of proposed development sites will be included in design of future improvements or mitigation projects. The Florida Department of State, Division of Historical Resources will be provided with findings of that preliminary survey, and will review development plans. DHR will also be consulted regarding any additional management actions needed to protect potential cultural resources on the Flinn Tract. Cultural resource protection strategies will include the identification and report to the Indian River County Sheriffs Office and DHR of any activities detrimental to known cultural sites. New sites will be submitted to DHR for inclusion in the Florida Master Site File as they are identified.

LAND USE MANAGEMENT

Access, Recreation and Outreach

The Intergovernmental Management Agreement between Indian River County and the St. Johns River Water Management District provides that "recreational activities planned or conducted within the wetlands and other naturally vegetated areas shall be resource-based, and the development of recreational facilities within the wetlands restricted to trails, boardwalks, or other alterations which facilitates access for the passive/ non-consumptive recreational user".

The Oslo Riverfront Conservation Area provides an excellent opportunity for resource compatible uses such as picnicking, walking and hiking, bird watching, nature appreciation, environmental education, and canoeing. Improvements were constructed on the original property in 1998 through funding by FIND and by the Department of Environmental Protection's Office of Greenways and Trails. These improvements are depicted on the Conceptual Development Plan, and include limited paved parking, the Herb Kale Nature Trail with benches and interpretive sign displays, boardwalks to access wetlands, an observation platform and an observation tower to afford an aesthetic view of the Indian River Lagoon and wetlands, and a canoe landing to provide access to the conservation area from the lagoon. A short, universally accessible loop trail meandering through the maritime hammock is provided to accommodate persons with disabilities and anyone interested in an abbreviated tour of the property.

An active ORCA Volunteers group conducts regular guided tours of ORCA and assists with pest plant control and other stewardship activities. The ORCA Volunteers are supported by the Pelican Island Audubon Society (PIAS) and by the FMEL, which offers free volunteer training classes to promote citizen stewardship at ORCA and at other conservation areas.

In addition to the ORCA Volunteers, a cooperative effort has been established between the District, Indian River County, the FMEL, and the Indian River County School Board to utilize the Oslo Riverfront property to educate high school and middle school students about land management issues. Regional Envirothon school competitions are periodically hosted at the FMEL and ORCA properties.

Over the next five years, public use facilities will be developed on the Flinn Tract to provide an appropriate level of access and interpretation to that property, and to support the Indian River Land Trust's efforts to establish the Lagoon Greenway connecting public lands between the South Relief Canal and the 17th Street Bridge (see Conceptual Development Plan). These improvements should include a parking area with a grassed surface or pervious pavement to accommodate 15 to 20 vehicles, and an accessible loop trail approximately 1 mile in length to carry visitors through the hammock to a 1,200-foot boardwalk across the mosquito impoundment wetlands, to return along the existing impoundment dike trails. Interpretive signs should be installed at several points along the trail to interpret the natural resources, history and management of the area. A restroom may be added in this area in the future, if the level of use indicates that it is needed.

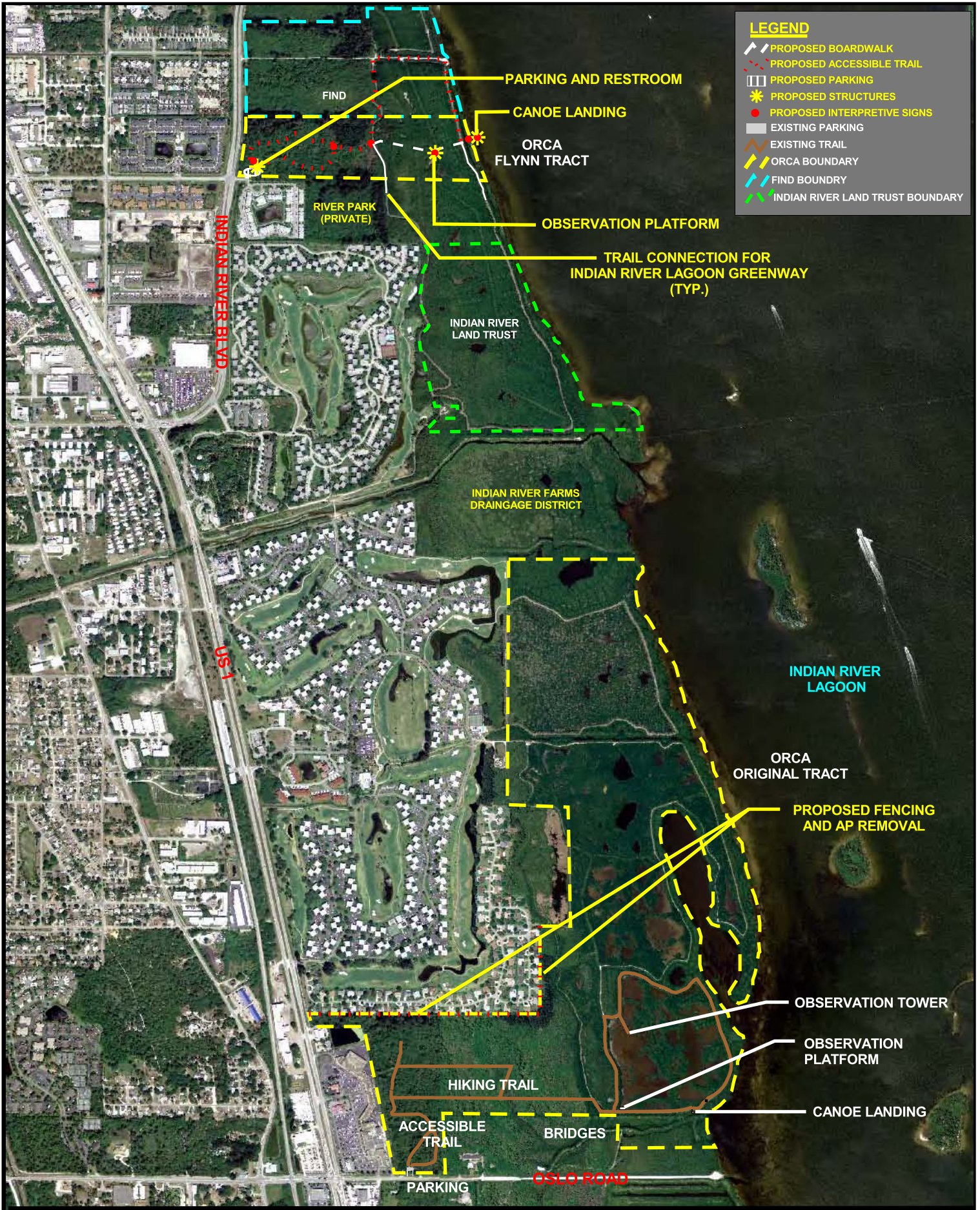

Development Costs

Costs associated with the Oslo Riverfront Conservation Area Flinn Tract development are categorized into initial development costs and annual maintenance costs. For planning purposes, it is estimated that annual maintenance costs will be approximately \$25 per acre of uplands or \$2,100 per year.

<u>Proposed Improvement</u>	<u>Function</u>	<u>Estimated Cost Range</u>
Entrance road Pervious parking area	At 8 th Street to parking For 15 to 20 vehicles	\$8,000 to 10,000
Trailhead information kiosk	For entire Greenway	\$750 to 1,500
Marked upland trails	Connect to impoundment roads	\$10,000 to 15,000
Elevated walkways (including permitting cost)	Across ditch & mangrove habitat to observation deck	\$180,000 to 220,000
Interpretive signage & wildlife viewing areas	Along trails and on elevated walkway as appropriate	\$2,000 to 3,000
Lagoon observation deck/ canoe landing	For lagoon viewing, fishing and access from the Lagoon	\$15,000 to 20,000
Improvement of impoundment roads	To better ensure safety of users 2" shell and grade	\$4,000 to 5,000 no silt fence \$6,000 to 7,000 w/ silt fence
Directional and information signage	As needed to ensure safe and enjoyable user experience	\$1,000 to 1,200
Gate	As needed to prevent access to adjacent non-participating landowners, etc.	\$400 to 600
Fencing (3,400 l.f.)	At SW corner of original parcel	<u>\$28,000</u>
Total Construction Estimates		\$251,150 to \$306,300
15% Contingency	Add for pre-design flexibility	\$37,700 to \$45,900
Design, Permit, & Construction Inspection		<u>\$15,000 to 25,000</u>
	MAXIMUM TOTAL	\$303,850 to \$377,245

ADMINISTRATION

Acquisition

The are no plans for additional acquisition for the ORCA north of Oslo Road, at this time. South of Oslo road, across from the ORCA parking lot, the County is pursuing acquisition of a one-acre parcel adjacent to conservation land. If acquisition is successful, the County will seek cost-share funding through the Florida Communities Trust Program of the Department of Community Affairs.

Cooperative Agreements, Leases, Easements and Special Use Authorization

With the exception of the Intergovernmental Management Agreement between the County, the District as amended to include FIND (discussed in the introduction of this plan), there are no cooperative agreements, leases, easements or special use authorizations on the property at this time. Cell towers, although authorized for some District lands, are not considered appropriate uses for the ORCA property.

Revenue Generation

There are no activities generating revenue at the ORCA.

IMPLEMENTATION CHART

Following is a schedule of activities for the ongoing management and additional development of the Oslo Riverfront Conservation Area.

<u>Activity</u>	<u>Time frame</u>	<u>Responsibility</u>
Guided tours	Periodic	Volunteers
Trails and facilities maintenance	Monthly or as needed	County staff
Trash removal	Daily	County staff
Exotic plant control	Periodic	Volunteers, County, Mitigation Projects
Mosquito impoundment maintenance	As needed	Indian River Mosquito Control District
New facilities development	2010-2015	County staff
Security – install boundary fencing	2010-2011	County staff
Security - ongoing coordination with IRC Sheriffs Office	Monthly or as needed	County staff
Water Resources – work with District, IRCMCD, FIND and FDOT to manage and improve water quality and wetland habitats	Periodic	County staff, District, IRCMCD and FIND

Upland restoration – apply mechanical/chemical restoration methods to 15-acre scrubby flatwoods community	Dependent on funding	County staff
Cultural resource protection – conduct reconnaissance-level survey prior to ground disturbing projects	2010-2014	County staff
Cultural resource protection – report detrimental activities to law enforcement and DHR	As needed	County staff
Exotic plants – Remove 10 ac. Of Brazilian pepper 11 ac. of Australian pine and 5 ac. of air potato vine and replant with native spp.	2010-2014	County staff

APPENDIX

**Interagency Management Agreement
Plant and Animal List
IRMCD Impoundment Management Plan
IRLT Lagoon Greenway Plan**

**FIRST AMENDMENT TO THE
OSLO RIVERFRONT CONSERVATION AREA
INTERGOVERNMENTAL MANAGEMENT AGREEMENT**

THIS AMENDMENT, entered into this 12th day of May, 1999, by and between THE GOVERNING BOARD OF THE ST. JOHNS RIVER WATER MANAGEMENT DISTRICT, a public body existing under Chapter 373 of the Florida Statutes, whose mailing address is P.O. Box 1429, Palatka, Florida 32178-1429 (hereinafter called "DISTRICT"), the FLORIDA INLAND NAVIGATION DISTRICT, an independent district of the State of Florida, whose mailing address is 1314 Marcinski Road, Jupiter, Florida 33477 (hereinafter called "FIND") and INDIAN RIVER COUNTY, a public body existing under the laws of the State of Florida, whose mailing address is 1840 25th Street, Vero Beach, Florida 32960 (hereinafter called the "COUNTY").

WITNESSETH:

WHEREAS, the DISTRICT, FIND, and the COUNTY jointly acquired a parcel of real property located in Indian River County (hereinafter called the "FLINN PROPERTY"); and

WHEREAS, on November 5, 1991, the DISTRICT and the COUNTY entered into an Intergovernmental Management Agreement, hereinafter referred to as the "Agreement" attached hereto as Exhibit "A" and by this reference made a part hereof, to allow the COUNTY to manage the Oslo Riverfront Conservation Area; and

WHEREAS, the DISTRICT, FIND, and the COUNTY entered into a participation agreement on March 5, 1998 stipulating that an Intergovernmental Management Agreement be drawn up setting forth the levels of responsibilities on the FLINN PROPERTY; and

WHEREAS, the DISTRICT, and the COUNTY desire to amend the Agreement to allow the DISTRICT to include additional land within the Oslo Riverfront Conservation Area rather than to create a new Intergovernmental Management Agreement solely for the FLINN PROPERTY; and

WHEREAS, the DISTRICT and the COUNTY hereby desire to add FIND as a management participant for the FLINN PROPERTY, and FIND desires to be included as a management participant for the FLINN PROPERTY under the Agreement.

NOW, THEREFORE, the DISTRICT, FIND and the COUNTY hereby agree as follows:

1. FIND is hereby added as a party to the Agreement and Exhibit A of the Agreement is hereby amended by adding the following described land, known as the Flinn Property (37.6 acres, Indian River County), Florida:

**SEE EXHIBIT "B" ATTACHED HERETO AND
BY REFERENCE MADE A PART HEREOF**

2. The existing management plan for the Oslo Riverfront Conservation Area shall be amended within one (1) year to include management of the FLINN PROPERTY. This amendment and all future amendments shall be approved by all parties in accordance with the terms of the Agreement. No development shall occur on the FLINN PROPERTY that is not included in the management plan.

3. The DISTRICT will assume primary management responsibilities on the FLINN PROPERTY, subject to the availability of funds, for the following:

- a. Assistance with land management activities as requested by the COUNTY.

4. FIND will, subject to the availability of funds, assist the COUNTY by providing funding for invasive vegetation management on the FLINN PROPERTY. Funding will be in the amount equal to FIND'S participation in the purchase of the FLINN PROPERTY, which was twenty-five percent (25%). FIND may also provide funding assistance to the COUNTY for the development of public recreational opportunities on the FLINN PROPERTY. The funding provided may be up to fifty percent (50%) of the total cost of improvements.

5. The COUNTY will assume primary management responsibilities, subject to the availability of funds, for the following:

- a. Maintenance and repair costs of the entrance roadway for the FLINN PROPERTY.
- b. Providing public recreational opportunities.
- c. Providing day to day maintenance (e.g. garbage removal) and security for the FLINN PROPERTY.
- d. Removing invasive terrestrial and aquatic plant species.

It is understood and agreed by the DISTRICT, FIND and the COUNTY that in each and every respect the terms of the Agreement, except as amended hereby, shall remain unchanged, and the same is hereby ratified, approved and confirmed by the DISTRICT, FIND and the COUNTY.

IN WITNESS WHEREOF, the parties hereto have duly executed this Amendment through their duly authorized signatories to become effective on the date and year first above written.

ST. JOHNS RIVER WATER MANAGEMENT DISTRICT

[Signature]
J. DANIEL ROACH, CHAIRMAN

ATTEST

[Signature]
OTIS A. MASON, SECRETARY

(SEAL)

STATE OF FLORIDA
COUNTY OF PUTNAM

The foregoing Amendment was acknowledged before me this 12th day of MAY 1999, by J. Daniel Roach and Otis A. Mason, personally known to me and known to me to be the Chairman and Secretary, respectively, of the St. Johns River Water Management District.

(NOTARIAL SEAL)



Jodie F. Green
MY COMMISSION # CC786149 EXPIRES
October 26, 2002
BONDED THRU TROY FAIN INSURANCE, INC.

[Signature]
NOTARY PUBLIC
Print name: JODIE F GREEN
My Commission Expires:
OCTOBER 26, 2002

ATTEST:

[Signature]
CLERK

INDIAN RIVER COUNTY

[Signature]
Title: KENNETH R. MACHT, CHAIRMAN
BOARD OF COUNTY COMMISSIONERS
(APPROVED BY THE BOARD 3/9/99)

(SEAL)

[Signature]

STATE OF FLORIDA
COUNTY OF INDIAN RIVER

The foregoing Amendment was acknowledged before me this 11 day of March 1999, by ~~KENNETH B. MACHS~~ and ~~PATRICIA M. RIDG~~ personally known to me and known to me to be Board ~~Chairman~~ and ~~Deputy Clerk~~, respectively, of ~~Indian River County~~.

(NOTARIAL SEAL)

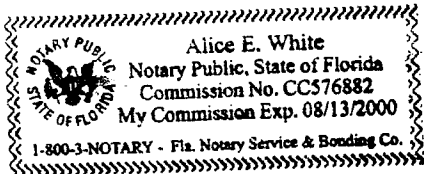

Alice E. White
NOTARY PUBLIC
Print name: _____
My Commission Expires: _____

FLORIDA INLAND NAVIGATION
DISTRICT

Ann R. Sherstein
Print Name: Ann R. Sherstein
Title: Chair

[Signature]
WITNESS
[Signature]
WITNESS

(SEAL)

STATE OF FLORIDA
COUNTY OF DUVAL

The foregoing Amendment was acknowledged before me this 23 day of April 1998, by ANN R. SHORSTEIN personally known to me and known to me to be Chair, respectively, of FIND

(NOTARIAL SEAL)

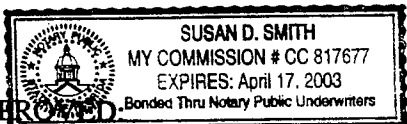

Susan D. Smith
NOTARY PUBLIC
Print name: Susan D. Smith
My Commission Expires: _____

[Signature]
JOHN W. WILLIAMS,
Deputy General Counsel
Office of General Counsel
SJRWMD

EXHIBIT A

INTERGOVERNMENTAL MANAGEMENT AGREEMENT

THIS INTERGOVERNMENTAL MANAGEMENT AGREEMENT (hereinafter called "AGREEMENT") is entered into as of the 5 day of November, 1991, between the ST. JOHNS RIVER WATER MANAGEMENT DISTRICT (hereinafter called the "DISTRICT") and INDIAN RIVER COUNTY (hereinafter called the "COUNTY");

W I T N E S S E T H:

WHEREAS, the DISTRICT and the COUNTY on August 21, 1991 purchased real property in Indian River County, Florida, as described in Exhibit A attached hereto (hereinafter called the "PROPERTY"), with each party acquiring an undivided one-half interest; and

WHEREAS, the DISTRICT acquired an undivided one-half interest in the PROPERTY for the purposes of water management, water supply and the conservation and protection of water resources; and

WHEREAS, the COUNTY acquired an undivided one-half interest in the PROPERTY for the purposes of providing environmental protection and public recreation; and

WHEREAS, the COUNTY has personnel and experience to provide for the management and maintenance of recreational areas and facilities.

NOW THEREFORE, the parties hereto, for and in consideration of the premises and the mutual covenants and agreements hereinafter contained, hereby covenant and agree as follows:

1. The term of this AGREEMENT is for a period of 30 years, commencing on the 5 day of November, 1991 and terminating on the 4 day of November, 2021.

2. The DISTRICT and the COUNTY mutually agree that any use or development of the PROPERTY will be subject to the following conditions:

a. the function and condition of the PROPERTY with respect to water management, water supply and the conservation and protection of water resources as set forth in Section 373.59(3) Florida Statutes will be maintained or enhanced and the PROPERTY will be managed to control the growth of non-native invasive plant species as required by Section 375.045(3), Florida Statutes;

b. no activities shall be conducted, within the WETLANDS as delineated on the map attached hereto and marked Exhibit B or other naturally vegetated areas, which damage fish or wildlife, or their habitats, or which alter natural drainage or floodplains or result in erosion, siltation or other forms of water pollution;

c. recreational activities planned or conducted within WETLANDS and other naturally vegetated areas shall be resource-based (i.e., dependent on existing elements of the natural environment) and the development of recreational facilities within the WETLANDS shall be restricted to trails, boardwalks, or other alterations which facilitate access for the passive/non consumptive recreational user;

d. the DISTRICT may engage in construction or other activities necessary for water management purposes provided that such construction or activities are described within the approved management plan;

e. the COUNTY may develop user-oriented recreational facilities (i.e., those not dependent on existing elements of the natural environment) on portions of the PROPERTY outside the WETLANDS provided that the water resource values of the affected land existing prior to development are not diminished;

f. nothing contained in this AGREEMENT shall be construed as a waiver of or contract with respect to the regulatory or permitting authority of the DISTRICT as it now or hereafter exists under applicable laws, rules and regulations.

3. The DISTRICT and the COUNTY shall, within one (1) year from the effective date of this Agreement, jointly develop a mutually acceptable management plan for the PROPERTY. Any and all improvements or permanent alterations to the PROPERTY must be described within a plan approved by both parties to this AGREEMENT prior to their implementation. The DISTRICT shall assume primary responsibility for drafting the plan as it relates to the manipulation of the natural vegetative communities and the area within the WETLANDS. The COUNTY shall assume primary responsibility for drafting the plan as it relates to the areas OUTSIDE the WETLANDS and the development and operation of any recreational and educational facilities. An amendment to the plan may be proposed by either party to this AGREEMENT

at any time, however, both parties must agree in writing upon the amendments before said amendments are incorporated into the plan.

4. Prior to agreement by both parties to a management plan, the COUNTY will assume responsibility for the surveillance and security of the PROPERTY. Land management questions will be settled by the mutual assent of both parties to the agreement.

5. The COUNTY shall bear the cost of the planning, construction, operation and maintenance of any recreational facility on the PROPERTY. The COUNTY shall also provide the personnel and resources necessary to monitor and protect the PROPERTY and to insure the safety of the public.

6. The COUNTY may retain any fees or other revenues collected in association with any recreational or educational facilities or programs operated by the COUNTY or a third party under contract with the COUNTY; provided, however, that any revenue derived from the use and management of the PROPERTY shall be utilized by the COUNTY for management, maintenance and capital improvement costs for the PROPERTY or for acquisition of other lands meeting the criteria set forth in Chapter 373.59, Florida Statutes.

7. All structures or improvements placed upon or moved in or upon the PROPERTY by the COUNTY or the DISTRICT shall be deemed the personal property of the party placing or moving the personal property and shall not be attached to the land as a fixture. Should either party sell or otherwise relinquish its ownership interest in the property, the party relinquishing its ownership and interest shall remove its personal property unless the DISTRICT and the COUNTY jointly agree to some other method of disposition. Should either party sell or otherwise relinquish its ownership interest in the property, the other party shall have a right to purchase said interest on the same terms and conditions as any prospective valid conveyances for consideration. Such right shall be exercised in writing within 30 days from notice of prospective sale/relinquishment of ownership interest.

8. Each party shall pay all lawful debts incurred by the party with respect to the PROPERTY and shall satisfy all liens of contractors, subcontractors, mechanics, laborers, and materialmen with respect to any construction, alteration and repair in and on the PROPERTY, and any

improvements thereon authorized by either party, its agents, or employees, and shall to the extent permitted by law, indemnify the other party against all legal costs; and charges, including attorney's fees reasonably incurred and reasonable attorneys' fees on appeal, in any suit involving any claims, liens, judgments or encumbrances suffered by either party as a result of the use or occupancy of the PROPERTY or any part thereof by either party, its agents or employees. Further, neither party shall have any authority to create any liens for labor or material on or against the other party's interest in the property, and all persons contracting with either party for the construction or removal of any structure, or for the erection, installation, alteration or repair of any structure or improvement on the PROPERTY, including all materialmen, contractors, mechanics and laborers involved in such work, shall be notified by the party authorizing the work that they must look to that party only to secure the payment of any bill or account for work done or material furnished during the term of this AGREEMENT.

9. Notwithstanding any clause to the contrary, nothing under the terms of this AGREEMENT shall render one party to this AGREEMENT liable for PROPERTY damages or personal injury resulting from any activities of the other. Further, each party agrees to indemnify the other from and against all liability, loss or damage of any kind whatsoever that either party may suffer in consequence of the activities of the other party upon the PROPERTY, whether it is caused by the negligence or intentional activities of the other party, its agents, employees, those authorized to enter the PROPERTY or otherwise, including, but not limited to, all attorneys' fees, investigation fees, court costs and all other costs and expenses whether direct or indirect, incurred in the compromise, attempted compromise, trial, appeal or arbitration of claims, including attempts to enforce this AGREEMENT. However, nothing in this AGREEMENT is intended or should be construed as a waiver of sovereign immunity enjoyed by the parties signatory hereto, as provided by Section 768.28, Florida Statutes.

10. During the term of this AGREEMENT, the COUNTY shall pay any and all taxes (including but not limited to intangible personal property taxes and ad valorem taxes) or special assessments which may be levied or assessed against the PROPERTY or the improvements and personal property of the COUNTY or its leasehold interest in the PROPERTY and the improvements and personal property.

11. Should either party operate concessions through third parties, then the concessionaires shall be required to obtain from an insurance company licensed in the State and acceptable to the other party, liability or indemnity insurance providing for mutually acceptable minimum limits per person or claims arising from any one incident and with respect to bodily injuries or death resulting therefrom, and for damage to property suffered or alleged to have been suffered by any person or persons resulting from operations under any agreement between either party and its concessionaires. Each party shall be named as an additional insured party for any such policies.

12. Either party to this AGREEMENT shall have the right, at any time, to inspect the premises and the activities by the other party to insure compliance with the applicable operational guidelines, specifications and terms of this AGREEMENT.

IN WITNESS WHEREOF, the parties hereto have duly executed this AGREEMENT to become effective as of the date and year first above written.

Signed, sealed and delivered in the presence of:

Elizabeth Delleme
Angela Waterhouse

COUNTY

The County of Indian River, Florida

By: *Richard N. Bird*
Richard N. Bird, Chairman
Board of County Commissioners

Attest: *Jeffrey Barton*
Jeffrey Barton
Clerk of the Circuit Court
Angela Waterhouse
(SEAL) D.C.

Executed on: November 5, 1991

Signed, sealed and delivered in the presence of:

Debbie Willming
Paul D. Denny

DISTRICT

St. Johns River Water
Management District

By: *Joe E. Hill*
~~Samuel H. Gray~~ Chairman
Joe E. Hill,

ATTEST:

By: *Lenore N. McCullagh*
~~Maxine G. Fike~~, Secretary
Lenore N. McCullagh,
(SEAL)

Executed on: 11/13, 1991

STATE OF FLORIDA
 COUNTY OF INDIAN RIVER

The foregoing instrument was acknowledged before me this 6th day of November, 1991 by Richard N. Bird and Jeffrey Barton, the Chairman of the County Commission and the Clerk of the Circuit Court respectively, on behalf of the County of Indian River, Florida.

Patricia Bargo Held
 Notary Public - State of Florida

My Commission Expires



STATE OF FLORIDA
 COUNTY OF PUTNAM

The foregoing instrument was acknowledged before me this 13th day of November, 1991 by Joe E. Hill and Lenore N. McCullagh, as Vice Chairman and Secretary, respectively, on behalf of the Governing Board of the St. Johns River Water Management District.

Sharon S. Ferguson
 Notary Public - State of Florida

My Commission Expires:

NOTARY PUBLIC, STATE OF FLORIDA,
 MY COMMISSION EXPIRES: OCT. 29, 1992,
 BONDED THRU NOTARY PUBLIC UNDERWRITERS

Indian River Co	Approved	Date
* Admin.	<u>WIC</u>	<u>10-28-91</u>
* Legal	<u>TPD</u>	<u>10-24-91</u>
Budget		
Dept.	<u>RMK</u>	<u>10/23/91</u>
* Risk Mgr.	<u>ASJ</u>	<u>10-24-91</u>

APPROVED AS TO FORM:

John W. Williams
 JOHN W. WILLIAMS, S.J.R.W.M.D.
 Sr. Assistant General Counsel
 Office of General Counsel

EXHIBIT A
(Page 1 of 2)

SURVEYOR'S DESCRIPTION

THAT PORTION OF GOVERNMENT LOT 6 IN SECTION 18, TOWNSHIP 33 SOUTH, RANGE 40 EAST; THAT PORTION OF SECTION 19 AND GOVERNMENT LOTS 1, 2, 3, AND 4 IN SECTION 19, TOWNSHIP 33 SOUTH, RANGE 40 EAST; AND ALL OF GOVERNMENT LOT 1, SECTION 20, TOWNSHIP 33 SOUTH, RANGE 40 EAST, INDIAN RIVER COUNTY, FLORIDA, MORE PARTICULARLY DESCRIBED AS FOLLOWS:

COMMENCE AT THE SOUTHEAST CORNER OF THE SOUTHWEST 1/4 OF SAID SECTION 19 AND RUN S.89°44'44"W. ALONG THE SOUTH LINE OF THE SOUTHWEST 1/4 OF SAID SECTION 19, SAID LINE BEING THE CENTERLINE OF THE 100 FOOT WIDE RIGHT OF WAY OF OSLO ROAD, FOR 305.00 FEET; THENCE RUN N.00°11'31"W. FOR 50.00 FEET TO THE NORTHERLY RIGHT OF WAY LINE OF SAID OSLO ROAD, SAID POINT BEING THE POINT OF BEGINNING OF THIS DESCRIPTION:

THENCE RUN S.89°44'44"W., ALONG THE NORTHERLY RIGHT OF WAY LINE OF SAID OSLO ROAD, FOR 568.32 FEET; THENCE RUN N.12°19'05"W. FOR 1620.99 FEET TO THE SOUTH LINE OF THE SOUTH 102.00 FEET OF THE NORTH 1018.80 FEET OF THE SOUTHWEST 1/4 OF SAID SECTION 19; THENCE RUN N.89°58'50"W., 1018.80 FEET SOUTH OF AND PARALLEL TO THE NORTH LINE OF THE SOUTHWEST 1/4 OF SAID SECTION 19, FOR 383.36 FEET; THENCE RUN N.12°19'05"W., 195.51 FEET EAST OF AND PARALLEL TO THE EASTERLY LINE OF THE 160 FOOT WIDE RIGHT OF WAY OF U.S. HIGHWAY NO. 1, FOR 2.06 FEET; THENCE RUN N.89°58'50"W., 1016.80 FEET SOUTH OF AND PARALLEL TO THE NORTH LINE OF THE SOUTHWEST 1/4 OF SAID SECTION 19, FOR 200.13 FEET TO THE EASTERLY RIGHT OF WAY LINE OF SAID U.S. HIGHWAY NO. 1; THENCE RUN N.12°19'05"W. ALONG THE EASTERLY RIGHT OF WAY LINE OF U.S. HIGHWAY NO. 1, FOR 102.35 FEET TO THE NORTH LINE OF THE SOUTH 102.00 FEET OF THE NORTH 1018.80 FEET OF THE SOUTHWEST 1/4 OF SAID SECTION 19; THENCE RUN S.89°58'50"E., ALONG THE NORTH LINE OF THE SOUTH 102.00 FEET OF THE SOUTH 1018.80 FEET OF THE SOUTHWEST 1/4 OF SAID SECTION 19, FOR 1819.26 FEET TO THE WEST LINE OF THE SOUTHEAST 1/4 OF SAID SECTION 19; THENCE RUN S.89°58'50"E., 916.80 FEET SOUTH OF AND PARALLEL TO THE NORTH LINE OF THE SOUTHEAST 1/4, FOR 675.60 FEET; THENCE RUN N.00°11'31"W., 675.60 FEET EAST OF AND PARALLEL TO THE WEST LINE OF THE SOUTHEAST 1/4 OF SAID SECTION 19, FOR 916.80 FEET TO THE SOUTH LINE OF THE NORTHEAST 1/4 OF SAID SECTION 19; THENCE RUN S.89°58'50"E. ALONG THE SOUTH LINE OF THE NORTHEAST 1/4 OF SAID SECTION 19, FOR 299.64 FEET; THENCE RUN N.00°14'17"W., ALONG THE WEST LINE OF THE EAST 10 ACRES OF THE SOUTHWEST 1/4 OF THE NORTHEAST 1/4 OF SAID SECTION 19 FOR 1316.30 FEET TO THE SOUTH LINE OF THE NORTHWEST 1/4 OF THE NORTHEAST 1/4 OF SAID SECTION 19; THENCE RUN N.89°43'27"W. ALONG THE SOUTH LINE OF THE NORTHWEST 1/4 OF THE NORTHEAST 1/4 OF SAID SECTION 19; THENCE RUN N.00°11'31"W., ALONG THE EAST LINE OF THE WEST 10 ACRES OF THE NORTHWEST 1/4 OF THE NORTHEAST 1/4 OF SAID SECTION 19, FOR 1319.21 FEET TO THE SOUTH LINE OF THE SOUTHEAST 1/4 OF SAID SECTION 18; THENCE RUN N.89°27'59"W., ALONG THE SOUTH LINE OF THE SOUTHEAST 1/4 OF SAID SECTION 18, FOR 361 FEET; THENCE RUN N.00°14'05"E., ALONG THE EAST LINE OF THE WEST 10 ACRES OF SAID GOVERNMENT LOT 6 FOR 1334.79 FEET; THENCE RUN S.89°34'21"E., ALONG THE NORTH LINE OF THE WEST BANK OF THE INDIAN RIVER AS FIELD LOCATED ON JANUARY 15, 1890; THENCE MEANDER SOUTHERLY ALONG SAID SAFE UPLAND ELEVATION LINE FOR APPROXIMATELY 6,500 FEET TO THE NORTH LINE OF THE SOUTH 330.00 FEET OF SAID GOVERNMENT LOT 4; THENCE RUN S.89°44'01"W., 330.00 FEET NORTH OF AND PARALLEL TO THE SOUTH LINE OF THE SOUTHEAST 1/4 OF SAID SECTION 19, FOR 822 FEET, MORE OR LESS; THENCE RUN N.00°14'17"W. FOR 319.00 FEET; THENCE RUN S.89°44'01"W., 649.00 FEET NORTH OF AND PARALLEL TO THE SOUTH LINE OF THE SOUTHEAST 1/4 OF SAID SECTION 19, FOR 1675.78 FEET TO EAST LINE OF THE SOUTHWEST 1/4 OF SAID SECTION 19; THENCE RUN S.89°44'44"W., 649.00 FEET NORTH OF AND PARALLEL TO THE SOUTH LINE OF THE SOUTHWEST 1/4, FOR 304.22 FEET; THENCE RUN S.00°11'31"E., 304.22 FEET WEST OF AND PARALLEL TO THE EAST LINE OF THE SOUTHWEST 1/4 OF SAID SECTION 19, FOR 599.00 FEET TO THE POINT OF BEGINNING, CONTAINING 297.9329 ACRES, MORE OR LESS.

DEED DESCRIPTION

Portions of Section 18, 19 and 20, Township 33 South, Range 40 East, Indian River County, Florida, being more particularly described as follows:

All of Government Lot 6, Section 18, Township 33 South, Range 40 East, LESS the West ten (10) acres of said Government Lot 6;

All of Government Lot 1, Section 20, Township 33 South, Range 40 East; Government Lots 1, 2 and 3; and Government Lot 4, LESS those portions of said Government Lot 4, having been heretofore conveyed to Indian River Mosquito Control District on May 10, 1954 by Warranty Deed recorded in Deed Book 88 at Page 261 of the Public Records of Indian River County, Florida, and LESS that portion of said Government Lot 4, heretofore conveyed to E. J. Wood, J. L. Law, et al, by Warranty Deed dated November 10, 1911 and recorded in Deed Book 12 at Page 66 of the Public Records of St. Lucie County, Florida; the Northwest 1/4 of the Northeast 1/4, LESS the West ten (10) acres thereof; and East ten (10) acres of the Southwest 1/4 of the Northeast 1/4; the Northwest 1/4 of the Southeast 1/4, LESS the West 675.6 feet of the North 916.8 feet thereof; the Southwest 1/4 of the Southeast 1/4, LESS the South 649 feet thereof; the South 102.00 feet of the North 1018.8 feet of the North 1/2 of the Southwest 1/4 thereof, lying East of the easterly right-of-way of U.S. Highway No. 1, LESS those parts thereof heretofore conveyed to Waldo E. Sexton and Elizabeth M. Sexton, his wife, by Warranty Deed dated May 2, 1951 and recorded in Deed Book 67 at Page 93 of the Public Records of Indian River County, Florida; the East 405.00 feet of the South 749.00 feet of the Southeast 1/4 of the Southwest 1/4, LESS the East 305.00 feet of the South 649 feet of said Southeast 1/4 of the Southwest 1/4, all being in Section 19, Township 33 South, Range 40 East, Indian River County, Florida, LESS the rights-of-way of Oslo Road and U.S. Highway No. 1, as now laid out and in use.

PARCEL B: All of the Southwest 1/4 of Section 19, Township 33 South, Range 40 East, lying East of the easterly right-of-way of U.S. Highway No. 1, LESS the South 749 feet of the East 405 feet, and LESS the North 1018.8 feet thereof, and LESS that portion lying parallel with the 570.01 feet easterly from (as measured at right angles to) the easterly right-of-way of U.S. Highway No. 1, and LESS the right-of-way of Oslo Road.

EXHIBIT A
(Page 2 of 2)

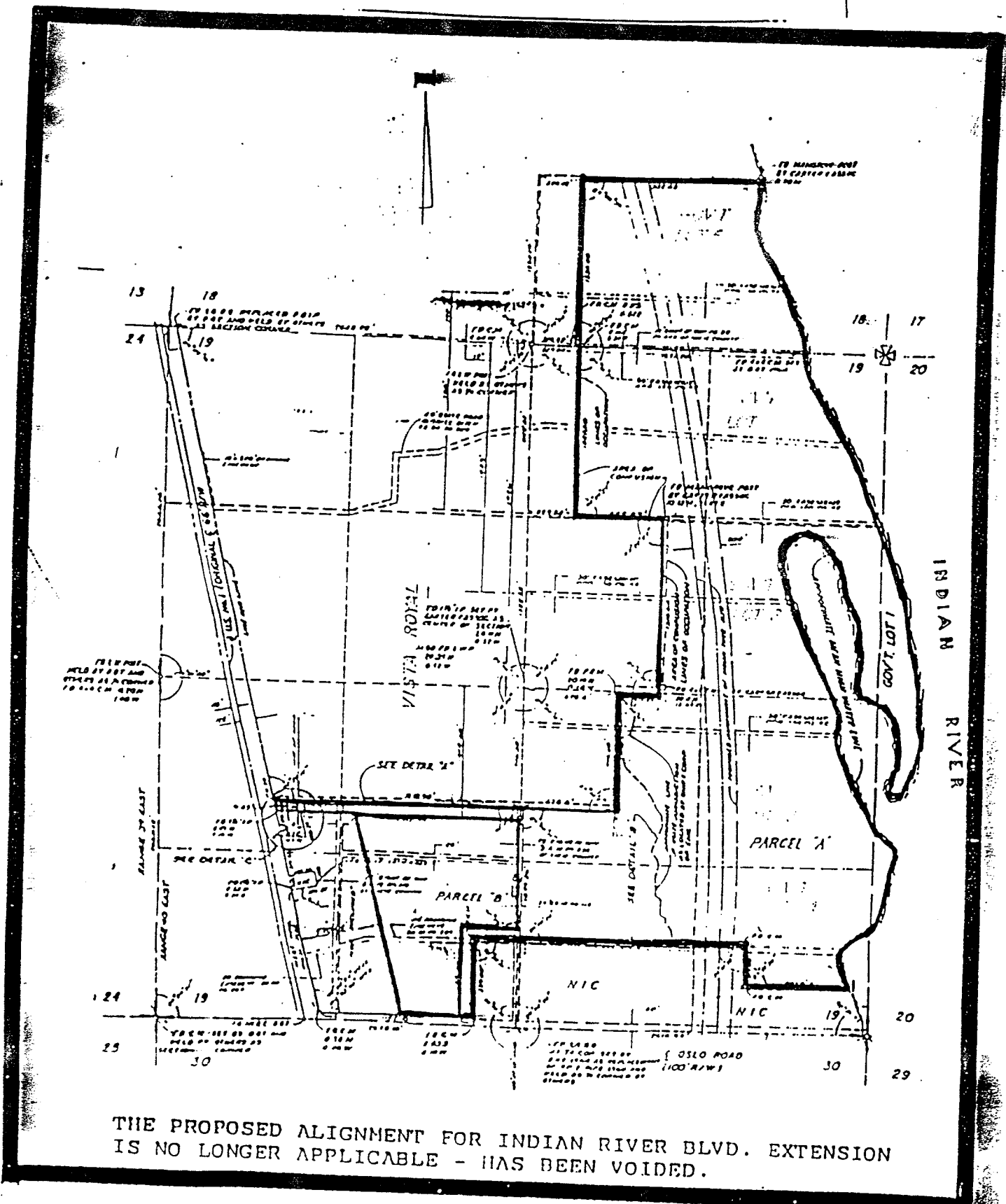

THE PROPOSED ALIGNMENT FOR INDIAN RIVER BLVD. EXTENSION
IS NO LONGER APPLICABLE - HAS BEEN VOIDED.

EXHIBIT B
(Page 1 of 2)

WETLAND DELINEATION

■ - WETLANDS

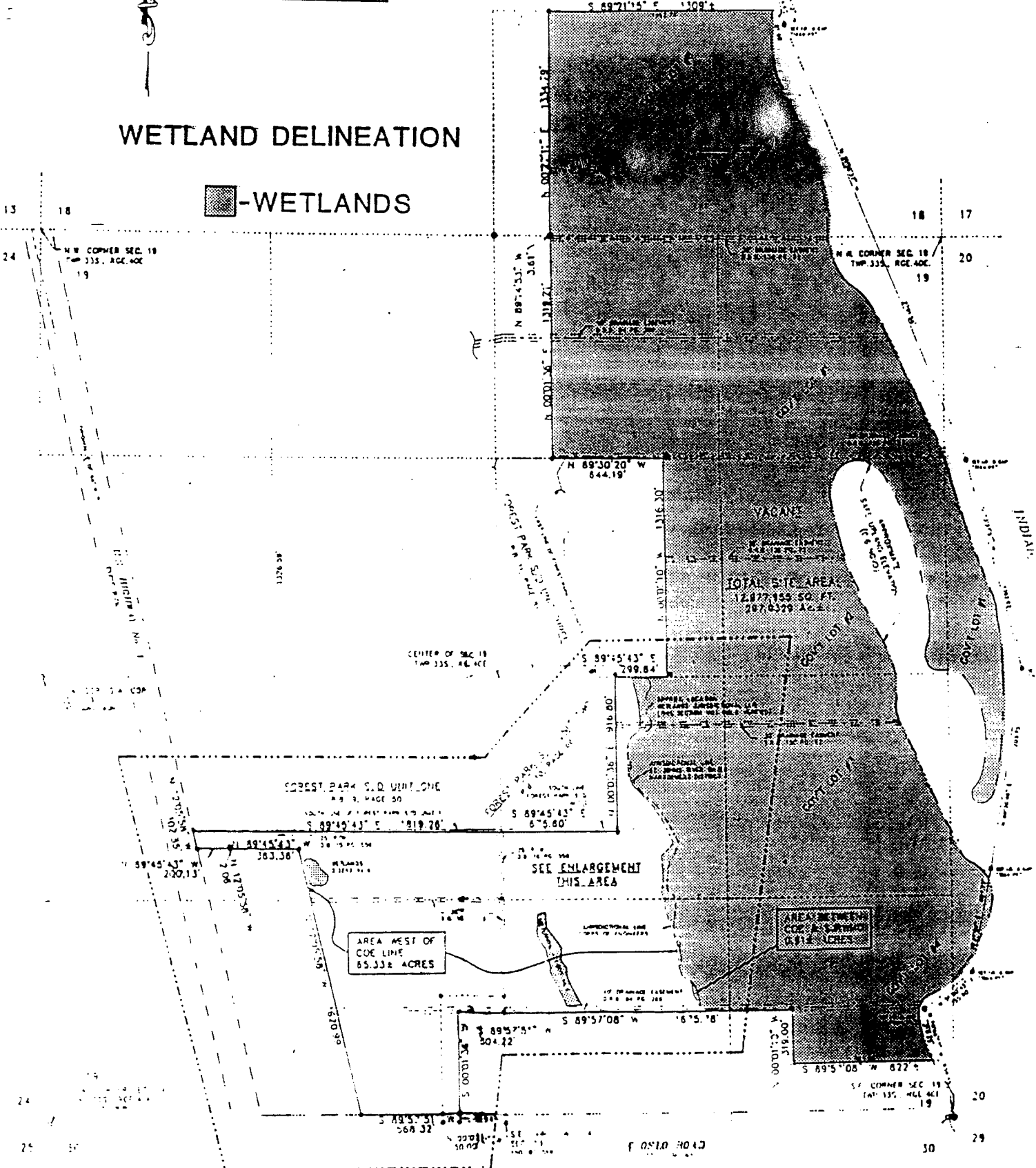

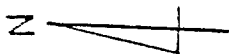
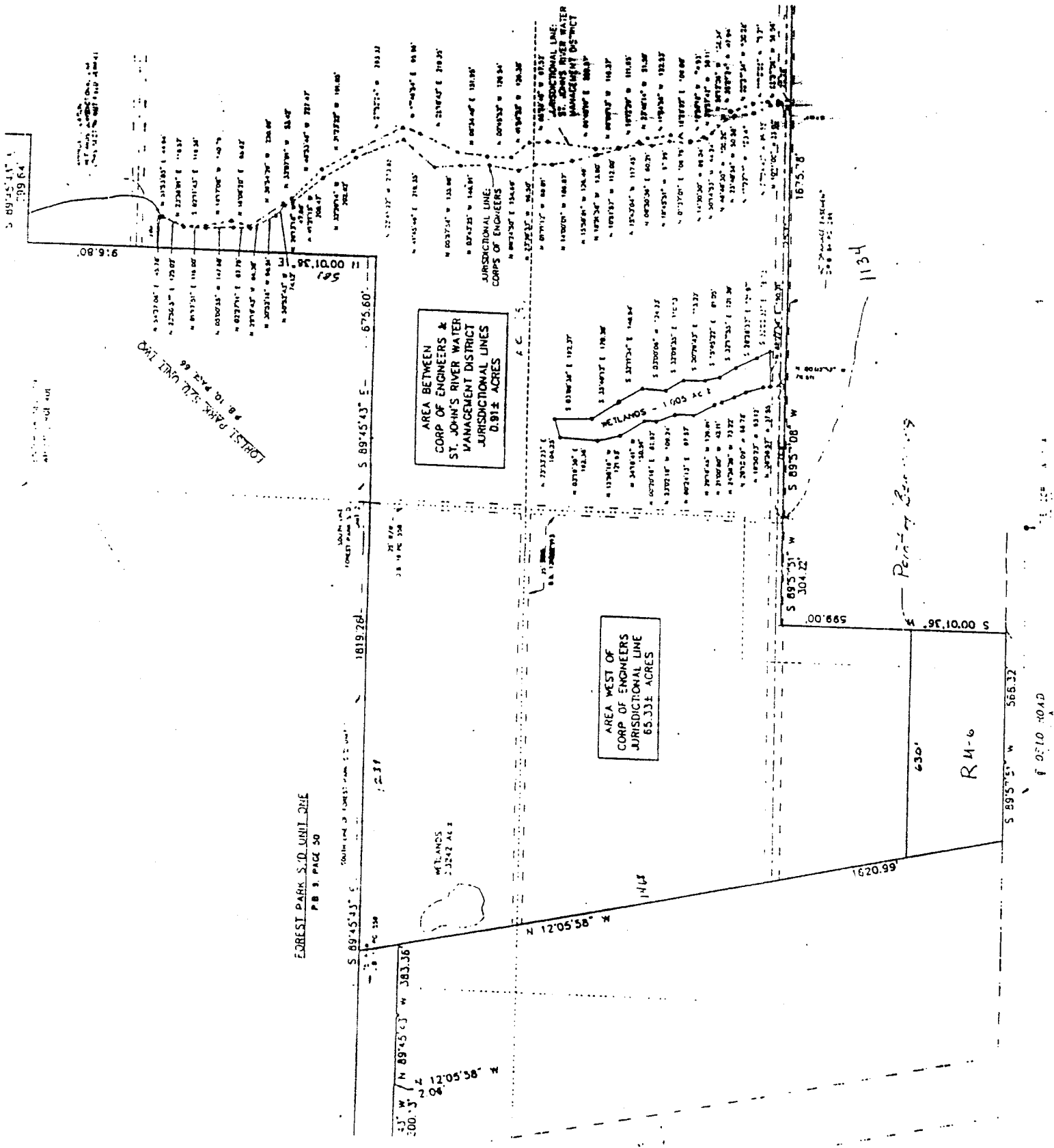

EXHIBIT B
(Page 2 of 2)



EDBEST PARK S.D. UNIT ONE
PB 3, PAGE 30

PEIRING BEARING

R4-6

0.010 ROAD

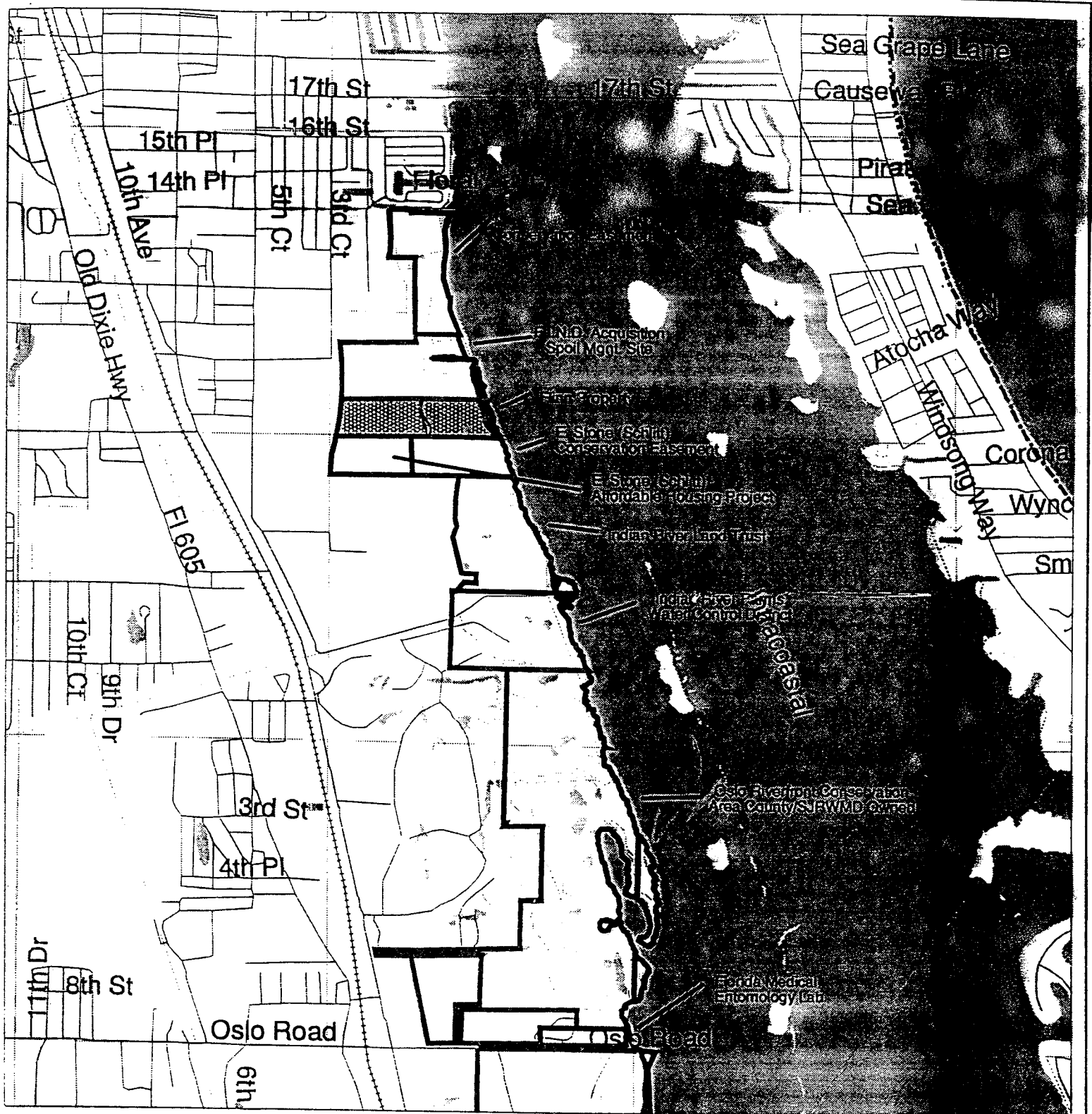

EXHIBIT B

Flinn Property



Oslo Riverfront Conservation Area Plant List

Common name	Species name	Habitat**
Rosary pea ^P	<i>Abrus precatorious</i>	P,R
Red maple	<i>Acer rubrum</i>	F
Leather fern	<i>Acrostichum danaeifolium</i>	W
Giant leather fern	<i>Acrostichum danaeifolium</i>	F,W
Pepper vine	<i>Ampolepsis arborea</i>	H
Broom sedge	<i>Andropogon glomeratus</i>	D,R
Marlberry	<i>Ardisia escallonioides</i>	H
Jack-in-the-pulpit	<i>Arisaema acuminatum</i>	H
Scarlett milkweed	<i>Asclepias curvassicum</i>	D,R
Aster	<i>Aster aff. dumosus</i>	D,R
Black mangrove	<i>Avicennia germinans</i>	W
Saltbush	<i>Baccharis halimifolia</i>	D,R
Saltwort	<i>Batis maritima</i>	W
Tarflower	<i>Bejaria racemosa</i>	P
Spanish needle	<i>Bidens alba</i>	D,R
Swamp fern	<i>Blechnum serrulatum</i>	H
Sea oxeye daisy	<i>Borrchia frutescens</i>	D,W
Tough bumelia	<i>Bumelia tenax</i>	P
Grey nicker bean	<i>Caesalpinia pulcherrima</i>	D
Beautyberry	<i>Callicarpa americana</i>	H
Cassia	<i>Cassia ligustrina</i>	R
Australian pine ^P	<i>Casuarina sp.</i>	R
Partridge pea	<i>Chamaecrista fasciculata</i>	D,P,R
Snowberry	<i>Chiococca alba</i>	H
Possum grape	<i>Cissus verticillata</i>	H,R
Sour orange	<i>Citrus aurantium</i>	H
Buttonwood	<i>Conocarpus erecta</i>	W
Scrub mint	<i>Conradina grandiflora</i>	P
Rattlebox	<i>Crotalaria spectabilis</i>	R
Carrotwood ^P	<i>Cupaniopsis anacardiodes</i>	D,H,R
Swamp cyrilla	<i>Cyrilla racemosa</i>	H
Coin vine	<i>Dalbergia ecastophyllum</i>	D
Air potato ^P	<i>Dioscorea bulbifera</i>	H,R
Butterfly orchid	<i>Encyclia tampensis</i>	H
Coralbean	<i>Erythrina herbacea</i>	D,H
White stopper	<i>Eugenia axillaris</i>	H
Frostweed	<i>Eupatorium serotinum</i>	D,R
Seaside gentian	<i>Eustoma exaltatum</i>	D
Strangler fig	<i>Ficus aurea</i>	D,H
Yellowtop	<i>Flaveria linearis</i>	D
Florida privet	<i>Forestiera segregata</i>	D,H
Blolly	<i>Guapira discolor</i>	Pl

Habenaria orchid	<i>Habenaria odontopetala</i>	H	
Firebush	<i>Hammelia patens</i>	Pl	
Scorpion tail	<i>Heliotropium angiospermum</i>	D	
Gallberry	<i>Ilex glabra</i>	P	
Morning glory	<i>Ipomoea cordatriloba</i>	R	
Virginia willow	<i>Itea virginica</i>	F	
Marsh elder	<i>Iva frutescens</i>	D	
Marsh mallow	<i>Kosteletzyka virginica</i>	W	
White mangrove	<i>Laguncularia racemosa</i>	W	
Lantana ^P	<i>Lantana camara</i>	D,R	
Peppergrass	<i>Lepidium virginicum</i>	D,R	
Sea lavender	<i>Limonium carolinianum</i>	D	
Christmas berry	<i>Lycium carolinianum</i>	D	
Rusty lyonia	<i>Lyonia ferruginea</i>	P	
Pink lyonia	<i>Lyonia lucida</i>	P	
Creeping cucumber	<i>Melothria pendula</i>	D,R	
Climbing hemp	<i>Mikania cordifolia</i>	D,R	
Wild balsam apple	<i>Momordica charantia</i>	D,R	
Red mulberry	<i>Morus rubra</i>	H	
Muscadine grape	<i>Muscadina munsoniana</i>	D,H,R	
Simpsons stopper	<i>Myrcianthes fragrans</i> var. <i>simpsoni</i>	F,H	
Wax myrtle	<i>Myrica cerifera</i>	D,F,H,P	
Myrsine	<i>Myrsine punctata</i>	D,H	
Lancewood	<i>Nectandra coriacea</i>	H	
Tuberous sword fern ^P	<i>Nephrolepis cordifolia</i>	H	
Basket grass	<i>Oplismenus setarius</i>	H	
Giant panicum ^P	<i>Panicum maximum</i>	D,R	
Virginia creeper	<i>Parthenocissus quinquefolia</i>	D,H,R	
Corky stemmed Redbay	passion flower <i>Persea borbonia</i>	<i>Passiflora suberosa</i>	D,H,R
Golden polypody	<i>Phlebodium aureum</i>	H	
Pokeberry	<i>Phytolacca americana</i>	D,H,R	
South Florida slash pine	<i>Pinus elliotti</i> var. <i>densa</i>	P	
Marsh fleabane	<i>Pluchea odorata</i>	D,R	
Wild plumbago	<i>Plumbago scandens</i>	H	
Wild poinsettia	<i>Poinsettia cyathophora</i>	D,R	
Resurrection fern	<i>Polypodium polypodioides</i>	H	
Cherry laurel	<i>Prunus carolinianum</i>	H	
Cattley guava ^P	<i>Psidium cattelianum</i>	H,R	
Guava ^P	<i>Psidium guajava</i>	H,R	
Soft-leaved wild coffee	<i>Psychotria nervosa</i>	H	
Shiny-leaved wild coffee	<i>Psychotria sulzneri</i>	H	
Pineland bracken fern	<i>Pteridium aquilinum</i>		

	var. caudatum	D,H,R
Myrtle oak	<i>Quercus myrtifolia</i>	P
Scrub live oak	<i>Quercus geminata</i>	P
Chapman oak	<i>Quercus chapmani</i>	P
Laurel oak	<i>Quercus laurifolia</i>	H,F
Live oak	<i>Quercus virginiana</i>	H
White indigo berry	<i>Randia aculeata</i>	D,H
Mangrove rubber vine	<i>Rhabdadenia biflora</i>	D
Red mangrove	<i>Rhizophora mangle</i>	W
Shiny sumac	<i>Rhus copallina</i>	H,P
Star rush	<i>Rhynchospora colorata</i>	R
Rouge plant	<i>Rivinia humilis</i>	H
Cabbage palm	<i>Sabal palmetto</i>	D,H,R
Glasswort	<i>Salicornia virginica</i>	W
Red salvia	<i>Salvia coccinea</i>	Pl
Elderberry	<i>Sambucus simpsoni</i>	H,R
Brazilian pepper	<i>Schinus terebinthifolius</i>	D,H,R
Saw palmetto	<i>Serenoa repens</i>	H,P,S
Sea purslane	<i>Sesuvium portulacastrum</i>	D
Catbrier	<i>Smilax</i> sp.	H,P,S
Twinleaf solanum ^P	<i>Solanum diphyllum</i>	D,H,R
Seaside goldenrod	<i>Solidago sempervirens</i>	D
	<i>Thelypteris interrupta</i>	H
Downy shield fern	<i>Thelypteris dentata</i>	H
Hottentot fern	<i>Thelypteris interrupta</i>	H
Widespread maiden fern	<i>Thelypteris kunthii</i>	H
Seaside mahoe ^P	<i>Thespesia populnea</i>	D
Quill-leaf wild pine	<i>Tillandsia setacea</i>	H,P
Spanish moss	<i>Tillandsia usneoides</i>	H
Green wild pine	<i>Tillandsia utriculata</i>	H,P
Ball moss	<i>Tillandsia recurvata</i>	H
Red wild pine	<i>Tillandsia fasciculata</i>	H,P
Poison ivy	<i>Toxicodendron radicans</i>	H,P,R
Gentian noddingscaps	<i>Triphora gentianoides</i>	H
Caesarweed ^P	<i>Urena lobata</i>	R
Shiny blueberry	<i>Vaccinium myrsinities</i>	P
Climbing cowpea	<i>Vigna luteola</i>	D,R
Southern fox grape	<i>Vitis rotundifolia</i>	H,R
Shoestring fern,		
Grass fern	<i>Vittaria lineata</i>	H
Wedelia ^P	<i>Wedelia triloba</i>	R
Tallowwood	<i>Ximenia americana</i>	P
Spanish bayonet	<i>Yucca aloifolia</i>	H
Hercules club	<i>Zanthoxylum clava-herculis</i>	Pl

**** HABITAT KEY**

D = Mosquito control dike

F = Freshwater wetlands (at quarry area)

H = Hammock

P = Scrubby pine flatwoods

Pl = Planted

R = Ruderal (disturbed) areas

S = Sand pine scrub

W = Coastal wetland

Prepared by *Janice Broda* with assistance from *Dr. Nancy Coile*, Botanist, Division of Plant Industry, Department of Agriculture and Consumer Affairs, *Richard Moyroud*, Mesozoic Landscapes, and *Bob Stolze*, Former Curator of Ferns, Illinois Natural History Survey

Oslo Riverfront Conservation Area Bird List

American Goldfinch	M	Chimney Swift	R
American White Pelican	M	Chipping Sparrow	M
American Oystercatcher	R	Chuck-will's-widow	R
American Coot	R	Clapper Rail	R
American Avocet	M	Common Moorhen	R
American Wigeon	M	Common Merganser	M
American Redstart	M	Common Goldeneye	M
American Woodcock	R	Common Loon	M
American Robin	M	Common Ground-Dove	R
American Bittern	M	Common Grackle	R
American Swallow-tailed Kite	V	Common Nighthawk	R
American Kestrel	M	Common Snipe	M
American Crow	V	Common Yellowthroat	R
Anhinga	R	Connecticut Warbler	M
Bald Eagle	R	Cooper's Hawk	R
Barn Swallow	M	Double-crested Cormorant	R
Barn Owl	R	Downy Woodpecker	R
Barred Owl	R	Dunlin	M
Belted Kingfisher	M	Eastern Phoebe	M
Bewick's Wren	M	Eastern Meadowlark	R
Black Rail	M	Eastern Bluebird	R
Black Vulture	R	Eastern Wood-Pewee	R
Black Skimmer	R	Eastern Screech-Owl	R
Black-and-white Warbler	M	Eastern Kingbird	R
Black-bellied Plover	M	European Starling	R
Black-crowned Night-Heron	R	Field Sparrow	M
Black-necked Stilt	R	Fish Crow	R
Black-throated Green Warbler	M	Forster's Tern	M
Black-throated Blue Warbler	M	Gadwall	M
Black-whiskered Vireo	R	Glossy Ibis	R
Blackpoll Warbler	M	Grasshopper Sparrow	M
Blue Grosbeak	R	Gray Catbird	M
Blue Jay	R	Gray Kingbird	R
Blue-gray Gnatcatcher	R	Gray-cheeked Thrush	M
Blue-winged Teal	M	Great Horned Owl	R
Boat-tailed Grackle	R	Great Black-backed Gull	M
Bonaparte's Gull	M	Great Blue Heron	R
Brown Creeper	M	Great Egret	R
Brown Thrasher	R	Great Crested Flycatcher	R
Brown Pelican	R	Greater Flamingo	V
Brown-headed Cowbird	M	Greater Yellowlegs	M
Brown-headed Nuthatch	V	Green-backed Heron	R
Bufflehead	M	Green-winged Teal	M
Canvasback	M	Gull-billed Tern	R
Carolina Wren	R	Hairy Woodpecker	R
Caspian Tern	R	Henslow's Sparrow	M
Cattle Egret	R	Hermit Thrush	M
Cedar Waxwing	M	Herring Gull	M

Hooded Merganser	M	Prothonotary Warbler	R
Hooded Warbler	M	Purple Gallinule	R
House Wren	M	Purple Martin	R
House Sparrow	R	Red Knot	M
Indigo Bunting	R	Red-bellied Woodpecker	R
Killdeer	R	Red-breasted Merganser	M
King Rail	R	Red-eyed Vireo	M
Lark Sparrow	M	Red-headed Woodpecker	R
Laughing Gull	R	Red-shouldered Hawk	R
Least Tern	R	Red-tailed Hawk	R
Least Sandpiper	M	Red-winged Blackbird	R
Least Bittern	R	Reddish Egret	R
Lesser Yellowlegs	M	Redhead	M
Lesser Scaup	M	Ring-billed Gull	M
Lesser Black-backed Gull	M	Ring-necked Duck	M
Lincoln's Sparrow	M	Ringed Turtle-Dove	R
Little Blue Heron	R	Rock Dove	R
Loggerhead Shrike	R	Rose-breasted Grosbeak	M
Long-billed Dowitcher	M	Roseate Spoonbill	R
Louisiana Waterthrush	M	Royal Tern	M
Magnificent Frigatebird	V	Ruby-crowned Kinglet	M
Mallard	M	Ruby-throated Hummingbird	R
Marbled Godwit	M	Ruddy Turnstone	M
Marsh Wren	R	Ruddy Duck	M
Merlin	M	Rufous-sided Towhee	R
Mottled Duck	R	Rusty Blackbird	M
Mourning Dove	R	Sanderling	M
Northern Harrier	M	Sandwich Tern	M
Northern Oriole	M	Savannah Sparrow	M
Northern Flicker	R	Scarlet Tanager	M
Northern Shoveler	M	Scrub Jay	R
Northern Gannet	V	Sedge Wren	M
Northern Waterthrush	M	Semipalmated Plover	M
Northern Mockingbird	R	Sharp-shinned Hawk	M
Northern Bobwhite	R	Sharp-tailed Sparrow	M
Northern Pintail	M	Short-billed Dowitcher	M
Northern Parula	M	Short-eared Owl	M
Northern Cardinal	R	Short-tailed Hawk	R
Orange-crowned Warbler	M	Smooth-billed Ani	V
Orchard Oriole	M	Snail Kite	V
Osprey	R	Snowy Egret	R
Ovenbird	M	Solitary Vireo	M
Painted Bunting	M	Song Sparrow	M
Palm Warbler	M	Sora	M
Peregrine Falcon	M	Spotted Sandpiper	M
Pied-billed Grebe	R	Summer Tanager	M
Pileated Woodpecker	R	Swainson's Thrush	M
Pine Warbler	R	Swamp Sparrow	M
Piping Plover	R	Tree Swallow	M
Prairie Warbler	R	Tricolored Heron	R

Tufted Titmouse	V
Turkey Vulture	R
Veery	M
Virginia Rail	M
Western Sandpiper	M
Whip-poor-will	M
White Ibis	R
White-cheeked Pintail	V
White-eyed Vireo	R
White-throated Sparrow	M
Wild Turkey	R
Willet	R
Wilson's Plover	R
Wimbrel	M
Wood Thrush	M
Wood Stork	R
Wood Duck	R
Worm-eating Warbler	M
Yellow Rail	M
Yellow Warbler	M
Yellow-bellied Sapsucker	M
Yellow-billed Cuckoo	R
Yellow-breasted Chat	M
Yellow-crowned Night Heron	R
Yellow-rumped Warbler	M
Yellow-throated Warbler	M
Yellow-throated Vireo	M

KEY

M=migrant, **R**=resident, **V**=visitor

Compiled by Dr. Jonathan Day,
Florida Medical Entomology Laboratory

Oslo Riverfront Conservation Area Snake List

Southern black racer	<i>Coluber constrictor priapus</i>
Yellow rat snake	<i>Elaphe obsoleta quadrivittata</i>
Southern ringneck snake	<i>Diadophis punctatus punctatus</i>
Rough green snake	<i>Opheodyrs aestivalis</i>
Banded water snake	<i>Nerodia fasciata fasciata</i>
Red rat snake (Corn snake)	<i>Elaphe guttata guttata</i>

Compiled by Bruce Dangerfield.
Based on casual field observations
as of February 24, 2000.

MANAGEMENT PLAN
FOR
INDIAN RIVER IMPOUNDMENT #18
(VISTA ROYALE)

PREPARED BY:

INDIAN RIVER MOSQUITO CONTROL DISTRICT
P.O. BOX 670
VERO BEACH, FL 32961

MAY 10, 1992

TABLE OF CONTENTS

I.	INTRODUCTION.....	1
II.	MANAGEMENT PLAN OBJECTIVES.....	1
III.	TECHNICAL CONSIDERATIONS	
	A. HYDROLOGICAL AND TOPOGRAPHICAL CONSIDERATIONS.....	2
	B. BIOLOGICAL.....	5
	C. MOSQUITO POPULATION CONTROL.....	9
IV.	MANAGEMENT CONSIDERATIONS.....	10
V.	LITERATURE CITED.....	12
VI.	APPENDICES	
	A. FIGURES.	
	1. IMPOUNDMENT LOCATION (REY/KAIN INVENTORY).	
	2. IMPOUNDMENT CONFIGURATION (REY/KAIN INVENTORY) -	
	WITH FIGURE 3, INCLUDES CURRENT CULVERT AND	
	PUMP STATION LOCATIONS.	
	3. IMPOUNDMENT DESCRIPTION (REY/KAIN INVENTORY).	
	4. PROPOSED CULVERT LOCATIONS.	
	5. WATER QUALITY AND FAUNAL SAMPLING SITES.	
	6. IMPOUNDMENT ELEVATIONS.	
	7. TIDAL INFORMATION.	
	8. WATER CONTROL STRUCTURES.	
	a. CULVERTS	
	b. FLAPGATES	
	c. BLEED-DOWN CULVERTS.	
	d. PUMP.	
	9. HISTORICAL AERIAL PHOTOGRAPH - 1943.	
	10. CURRENT AERIAL PHOTOGRAPH - 1992.	
	B. TABLES.	
	1. 1992 WATER QUALITY DATA.	
	a. DISSOLVED OXYGEN.	
	b. SALINITY.	
	c. TEMPERATURE.	
	2. 1992 FISH SAMPLING DATA (a-c).	
	3. AERIAL LARVICIDING DATA.	

**MANAGEMENT PLAN FOR
INDIAN RIVER IMPOUNDMENT #18
(SOUTH VISTA ROYALE)**

PREPARED BY:

**INDIAN RIVER MOSQUITO CONTROL DISTRICT
P.O. BOX 670
VERO BEACH, FL 32961**

I. INTRODUCTION.

This plan, which proposes improved management of Indian River (IR) Impoundment #18 (South Vista Royale), is in response to objectives as defined by the Subcommittee on Managed Marshes' (SOMM) for improving management of IR lagoon impoundments whenever possible. This impoundment, which has recently become public domain through purchase by Indian River County and the St. Johns River Water Management District, currently is not connected to the IRL. This proposed Rotational Impoundment Management (RIM) plan has been developed through an Indian River Mosquito Control District (IRMCD) contract with the Office of Entomology & Pest Control, Fla. Dept. of Agriculture and Consumer Services who are administering SWIM/St. Johns River Water Management District funds. This beneficial arrangement will allow quick implementation of the plan. The format for this management plan follows SOMM guidelines adopted in October 1989.

II. MANAGEMENT PLAN OBJECTIVES.

Since currently there are no culverts in Impoundment #18, the impoundment-lagoon connection being proposed will establish optimal culvert connection between the impoundment and IRL and provide for improved pumping capabilities through the installation of a permanent electric pump. Also, because of the existing system of interior (breached) dikes, a RIM management variation is possible and will be attempted here. IRMCD will reconnect the southeast impoundment cell (=approx. 40 acres) to the lagoon with two (2) 30 in. diameter culverts then leave this cell intertidal year-round. It will become part of the summer flooding schedule only if, or when, the mosquito production becomes problematic there.

The culvert opening and closing schedule proposed here for the remainder of the impoundment is consistent with other RIM plans for this portion of the IRL. Culvert closing will be in the late spring/early summer depending on rainfall patterns. The impoundment will be flooded to a maximum of 1.8 ft. NGVD, a minimal flooding level necessary to cover much of the marsh surface. Culverts will be opened in the late summer/early fall when rising lagoon levels historically allow lagoonal water to flood the high marshes. This typical RIM plan will allow for IRMCD to continue (and improve) source reduction mosquito control benefits within this impoundment

while providing for fish, wildlife enhancement and the improvement of impoundment water quality. The exception to this schedule is the southeast cell which, as mentioned, will remain open to the lagoon as long as mosquito conditions permit.

III. TECHNICAL CONSIDERATIONS.

A. HYDROLOGICAL AND TOPOGRAPHICAL CONSIDERATIONS.

1. **LOCATION.** Impoundment #18 is located in the southern, mainland portion of Indian River County directly to the west of the Vista Royale development (Figure 1). The south relief canal is 0.6 mi. north of the impoundment's northern edge. The relief canal is the nearest major source of freshwater. The impoundment extends down almost to Oslo Road (Florida Medical Entomology Laboratory road) which is approx. 2 miles north of the Indian River/St. Lucie Co. line.
2. **SIZE.** The Rey/Kain impoundment inventory lists Impoundment #1 at 133 acres. The maximum width of the impoundment is approx. 2000 ft. with a perimeter linear dike length of approx. 3.0 miles.
3. **TOPOGRAPHY.** Marsh elevations determined in March-May 1992 show a highly variable marsh topography (see Figure 6). The marsh contour ranges from deep interior ponds to many hillocks supporting red and white mangroves. Marsh elevations along the western impoundment quadrats dictate the need for a flooding elevation of approx. 1.8 ft. NGVD.
4. **DIKE CONFIGURATION.** The dike, which skirts the entire impoundment perimeter is intact and varies in elevation from approximately 2.5-3.5 ft. NGVD but with several low spots. There are also numerous interior dikes dividing the impoundment into 7 recognizable cells. All the interior dikes are breached allowing water to flow throughout the impoundment. Therefore water pumped into it at the pump station (NW corner) makes its way throughout the impoundment. There is also a Freshwater Pond (13 acres) which is adjacent to but not connected to the impoundment (Figure 2). We assume a freshwater well feeds this as it remains constantly flooded with nearly fresh water.

5. **SOIL TYPES.** Our source of information on Indian River soils is the U.S. Dept. of Agriculture's Soil Conservation Service. This USDA report defines Impoundment #18 soils as "McKee mucky clay loam". This soil is described as "level and very poorly drained...formed in unconsolidated loamy or clayey tidal deposits and is inundated by fluctuating tides twice a day....Slopes are less than 1 percent".
6. **HYDROGRAPHY.** Long-term lagoon tidal information for Indian River County is available from two sources - the Florida Medical Entomology's Oslo Road records (from 1959-1981) and the U.S. Dept. of Interior's records at the Wabasso Causeway (the southern extent of the Sebastian Inlet Management Area). The FMEL records are from the just outside the SE edge of Impoundment 18. Both tidal records demonstrate similar trends (i.e., seasonal highs in the late summer/fall with lowest water periods in the spring and summer) (Figure 7). Given Impoundment #18 close proximity to the FMEL station, we expect those tidal records to provide the most meaningful data for this site.

The Indian River Mosquito Control District's recent and proposed flooding elevation is 1.8 ft. NGVD. Our experience in this impoundment is that flooding to this level is necessary to inundate the many mosquito-producing hillocks at relatively high elevations.

7. **WATER CHEMISTRY INFORMATION** (See Figure #1 for sampling sites, Table 1 a-c for data). On eight occasions between Jan. 25 & April 25, 1992, dissolved oxygen (ppm), temperature (degrees C.) and salinity (ppt) was measured at up to 11 locations.

The measurements show fairly typical temperature and dissolved oxygen concentrations for the winter/spring months. However, note the low salinities at virtually all impoundment locations (maximum impoundment mean=11 ppt). The lagoonal canal, which skirts the impoundment's north side is the water source for mosquito control pumping and is nearly fresh (mean=1.3ppt). The canal receives input from the Vista Royale development.

Also of interest is an approx. 13 acre isolated freshwater pond along the impoundment's western edge. Salinities in the pond averaged 1.0 ppt.

8. **STRUCTURES.**
 - a. **EXISTING.** Currently there are no culverts in this impoundment. As mentioned, interior dikes are breached but no breaches occur in perimeter dikes.

- b. **PROPOSED.** This plan proposes to install 9-30 in. diameter culverts at the locations delineated on Figure 4. Eight culverts (#1-8) will connect the impoundment with the lagoon and one culvert (#9) will be placed in an interior dike at a current breach location. In accordance with SOMM guidelines on previously reviewed RIM plans, the culvert inverts will be placed at -1.0 ft. NGVD. Culvert locations have been chosen to try and provide optimal flushing through the impoundment when culverts are open to the lagoon.

The plan also includes 3 bleed-down culverts, a design currently being evaluated by IRMCD at IR Impoundment #22 (Golf Course/Indian River Blvd project). If experience shows them to provide improved water quality benefits, bleed-down culverts will be installed here as funding permits. Bleed-down culverts operate by allowing impoundment water pressure to slowly force bottom water through the culvert into the lagoon. Bleed-down culverts are planned to be placed near culverts #2, 4, & 6. A further description of how these culverts will be used is explained in IV.B. - MANAGEMENT CONSIDERATIONS.

9. **PUMP STATION.** The existing pump station (located at the impoundment's northwest corner, Figure 2), which is now used for a portable electric pump, will serve as the site for the stationary electric pump as well. Since electric service (3 phase) is available within a few hundred feet by Florida Power & Light, hook-up to a permanent pump should proceed smoothly. Please note that the salinities from the pump intake canal (along the north edge of Impoundment #18) are very low so during the summer flooding period, low salinity water will continue to flood the impoundment.
10. **ADJACENT AREAS.** Several impoundments are located to the north and south of IR Impoundment #18. Below is a brief description of the most significant nearby marshes.
 - a. **IR IMPOUNDMENTS #19 (NORTH VISTA ROYALE).** Adjacent to the north is a 52 acre impoundment which receives secondarily treated effluent from a polishing pond at the Vista Royale wastewater plant (max. capacity = 0.5 million gallons/day). Typically the flow of wastewater keeps this impoundment flooded year-round thereby controlling mosquitoes through impoundment. There is no connection between this impoundment and the lagoon (Carlson 1983, Carlson & Knight 1987).

- b. IR IMPOUNDMENTS #20 (VISTA GARDENS) & #21 (SCHLITTS). These two impoundments totalling 122 acres are just to the north of IR Impoundment #19 thus within approx. 0.75 miles from South Vista Royale. These impoundments are interconnected with a culvert therefore both are flooded from one pump station. They have no connection to the IR lagoon.
 - c. IR IMPOUNDMENT #17 (LOWENSTEIN). This 65 acre impoundment, abuts Oslo Rd. to the south, is breached and frequently is a producer of salt-marsh mosquitoes (Ae. taeniorhynchus or Ae. sollicitans) thus typically in the summer requiring at least several aerial applications of Altosand (=methoprene).
11. OWNERSHIP. Impoundment #18 (and adjacent upland parcels) were recently purchased by a joint venture between Indian River County and the St. Johns River Water Management District. Indian River County is currently developing a management plan for the entire area purchased which also includes adjacent uplands. This management plan is intended to serve as a part of that larger plan scheduled to be completed in the fall of 1992.

B. BIOLOGICAL SECTION.

1. AERIAL PHOTOGRAPHS. Figure 9 is a replication of a 1943 aerial photo. Please note the extent of parallel ditching conducted prior to 1943. The vegetation appears to be largely low-lying plants (probably Batis maritima and Salicornia virginica with mangroves lining deeper water. It is unknown the reason for the square area near the middle of the impoundment. It is possible that it was an early farming attempt of some sort. Figure 10 is a 1992 aerial. As is the case with many other impoundments throughout the county, please note the extent of dead vegetation primarily caused by the Dec. 1989 freeze.
2. VEGETATION.
 - a. PUMP CELL. Mostly dead plants with some new red mangroves (Rhizophora mangle) dominate this cell. Dense patches of widgeongrass (Ruppia maritima) are present.

- b. **NORTHEAST CELL.** This cell, which contains several large ponds (containing tarpon) also has mostly dead red mangroves with new ones coming in. In its interior are also some Brazilian pepper (Schinus terebinthifolius) on numerous hillocks. Scattered leather fern (Acrostichum spp.) and white mangroves (Laguncularia racemosa) is also present here. Dense patches of widgeongrass and a few scattered cattail (Typha spp.) are present. Also two types of ferns (apparently upland species) were noted.
- c. **EAST TIP CELL.** This cell is largely dead red with some white mangroves in the interior. There are some open areas in particular in the north portion of this cell. Primarily red mangroves are sprouting up in the interior with a few scattered black mangroves (Avicennia germinans). A few leather fern and cattails were also present along with widgeongrass.
- d. **CENTER CELL.** This cell is quite open with areas of dense dead red mangroves. New reds are colonizing. Widgeongrass and Chara are present. Numerous hillocks above the high water line occur here.
- e. **CENTER WEST CELL.** Dense areas of dead red mangroves are present with considerable recolonization by the same species along with scattered white & black mangrove. Also present are leather fern, Salicornia virginica (glasswort) on numerous hillocks.
- f. **SOUTHWEST CELL.** Dense areas of dead red mangroves but with much revegetation occurring. Live vegetation includes red & white with occasional black mangroves, also dense leather fern in some locations. Ruppia and cattails present. Some upland weeds/ground cover present in drier areas. Glasswort also present in a few locations.
- g. **SOUTHEAST CELL.** This cell is very open with, where vegetation is present, mostly red and infrequently white mangroves in the interior. Widgeongrass and Chara are also present.
- h. **FRESHWATER POND.** This pond, which is not connected to the impoundment, is densely vegetated with cattails and Chara.
- i. **IMPOUNDMENT DIKES.** The perimeter and interior dikes are vegetated similarly to dikes throughout IRC. Brazilian pepper dominates with scattered black mangroves, white mangroves and buttonwood (Conocarpus erecta). Some portions of the dike are densely vegetated with Sea daisy (Borrichia frutescens). In a few locations, Suaeda linearis (Sea blite) occurs.

3. **FAUNA.** On four occasions in 1992 (Feb. 15, Apr. 4,11,25) a variety of standard sampling techniques (e.g., seine, box trap, heart trap, cast net) were used to determine the qualitative make-up of fish and macrocrustaceans occurring in the impoundment and provide some density estimates. Figure 5 shows the location of the sampling stations and Tables 2a-c list the organisms collected (or observed), their relative numbers and size range.

Within Impoundment #18, the typical marsh resident fish were collected. It is interesting to also note the large numbers of Lucania parva (rainwater killifish) present probably because of the overall lower salinities here. Also note the presence of tarpon and striped mullet both in the impoundment and lagoon at the pump station location. It is expected that with culverts connecting the marsh and lagoon, transient fish use of the impoundment will increase.

Although the Freshwater Pond is not part of the impoundment per se, its close proximity provides additional habitat diversity in the area. In Table 2c note that 5 species were collected there including bluegill. This pond is a favorite for alligators.

Both wildfowl and waterfowl commonly use Impoundment #18. Long-time IRMCD field crew members verify that this marsh has long been a favorite among duck hunters. The present occurrence of duck blinds there further verifies this fact. On our numerous sampling trips to this marsh, many ducks were observed along with the typical marsh birds - Brown Pelican, White Pelican, Great Blue Heron, Tricolored Heron, Snowy Egret, Great Egret, White Ibis, Osprey, several passerine species and hundreds of Turkey Vultures! The avifaunal diversity of this area is impressive.

4. **CONSIDERATION FOR ENDANGERED SPECIES.** The April 1, 1991 "Official Lists of Endangered and Potentially Endangered Fauna and Flora in Florida", which is published by the Florida Game and Fresh Water Fish Commission (FGFWFC), provides a summary of plants and animals listed by several agencies. Using the designated status as defined by the FGFWFC and the USFWS, below are animals which occur on that list which have been observed or in our opinion are capable of occurring at Impoundment #1.

[SSC=Species of Special Concern; T=Threatened; T(S/A)=Threatened due to similarity of appearance; C2=A candidate for listing but not sufficient data to list; E=Endangered]

		FGFWFC	USFWS
a.	FISH.		
(1)	<u>Centropomus undecimalis</u> (Common snook)	SSC	
(2)	<u>Rivulus marmoratus</u> (Rivulus)	SSC	
b.	AMPHIBIANS/REPTILES.		
(1)	<u>Alligator mississippiensis</u> (American alligator)	SSC	T(S/A)
(2)	<u>Drymarchon corais couperi</u> (Eastern indigo snake)	T	T
(3)	<u>Gopherus polyphemus</u> (Gopher turtle)	SSC	C2
(4)	<u>Nerodia fasciata taeniata</u> (Atlantic salt marsh water snake)	T	T
c.	BIRDS.		
(1)	<u>Aiaia ajaja</u> (Roseate spoonbill)	SSC	
(2)	<u>Egretta caerulea</u> (Little blue heron)	SSC	
(3)	<u>Egretta rufescens</u> (Reddish egret)	SSC	C2
(4)	<u>Egretta thula</u> (Snowy egret)	SSC	
(5)	<u>Egretta tricolor</u> (Tricolored heron)	SSC	
(6)	<u>Haematopus palliatus</u> (American oystercatcher)	SSC	
(7)	<u>Haliaeetus leucocephalus</u> (Bald eagle)	T	E
(8)	<u>Mvcteria americana</u> (Wood stork)	E	E
(9)	<u>Pandion haliaetus</u> (Osprey)	SSC	
(10)	<u>Pelecanus occidentalis</u> (Brown pelican)	SSC	

Because our proposed management plan will establish seasonal lagoon-marsh connection and allow for more precise water level controls, we expect the plan to cause no further harm to these animals as compared to management conducted here since 1958.

Based on the study of RIM effects in IRC impoundments, we expect the habitat improvement brought about by RIM to generally benefit wading birds. The seasonal drying allowed by RIM should further improve bird feeding potential by concentrating fish in ponds and the perimeter ditch.

Research has demonstrated that RIM is basically compatible with the life cycle of several commercially and recreationally important fish, thus snook should benefit (O'Bryan et al). It is unclear what effect RIM management has on Rivulus. Current theory holds that a RIM managed impoundment is preferable to a closed impoundment (Scott Taylor, pers. com.) but there is a lack of documentation of what real effects RIM may have. It is anticipated that there will be no further deleterious effects by increasing the number of culverts.

Although impounding is believed to be harmful to the atlantic salt marsh snake by reducing their normal habitat during the summer, RIM implementation should not further harm this animal. Habitat should not deteriorate for the eastern indigo snake and the gopher tortoise.

Of all the animals listed, the potential adverse effects for the alligator are greatest. It is expected that making Impoundment #18 seasonally intertidal will increase salinities when tidal water is allowed to penetrate the marsh (i.e., fall/winter & spring). However, given that the Freshwater Pond should not be influenced by culverting and that salinities in Impoundment #19 (adjacent to the north) are virtually fresh, a large amount of freshwater habitat will remain in this immediate area for the alligators use.

C. MOSQUITO POPULATION CONTROL SECTION.

1. GENERAL. IRMCD controls salt-marsh mosquitoes by Integrated Pest Management (IPM) methods. This variety of methods include the seasonal flooding of impoundments, larviciding, and ground ULV (ultra low volume) adulticiding. The different elements of this IPM program are implemented on a need basis. Need is determined by incorporating reports from IRMCD entomologists, biologists and field personnel on the presence of larval or adult mosquitoes. Also, reports and service requests from local residents are taken into consideration. Currently,

IRMCD uses the insect growth regulator Altosid (methoprene) as its primary larvicide (applied aerially via fixed wing aircraft as Altosand) and Dibrom (naled) and Punt (permethrin) as its primary adulticides.

2. **PREVIOUS MANAGEMENT.**

a. **CONSTRUCTION AND WATER MANAGEMENT OF IMPOUNDMENT #1.** Impoundment #18 was constructed in 1958 following Fla. Dept. of Health guidelines, that only mosquito producing high marsh was to be impounded. Since its construction in 1958, Impoundment #18 has been flooded only during the summer months (approx. May - Oct.) when salt-marsh mosquitoes are problematic.

b. **LARVICIDING FOR SALT-MARSH MOSQUITOES.** Over the years, IRMCD has employed a variety of larvicides. They have included chlorinated hydrocarbons (DDT, BHC), paris green and Florida Formula Oil have been used in IRC salt marshes. Since the mid-1970's Altosid adsorbed to sand (Altosand) has been IRMCD's primary salt-marsh mosquito larvicide. To the best of our knowledge, all of the above-mentioned chemicals may have been used at Impoundment #18.

3. **CURRENT MANAGEMENT.** Currently at Impoundment #18 IRMCD employs an IPM program. This includes flooding of the impoundment during the summer months, typically larviciding the impoundment with Altosand when it is first pumped up in the late spring/early summer. Altosand is applied via fixed wing aircraft at the rate of approx. 8 lbs. per acre (=2.0+ oz. per acre) with a flagger directing the aircraft to ensure even coverage. Ground ultra low volume (ULV) adulticiding with Dibrom (naled) is conducted west of the impoundment in Vista Royale and nearby developments when the need is verified by District personnel.

4. **MOSQUITO PRODUCTION.** IRMCD has maintained records of aerial larviciding operations since 1976 with accurate records since 1984. For the period 1984-1991, all or a portion of Impoundment #18 was treated an average of 0.6 times per year (=52.8 acres/yr., Table 3).

IV. **MANAGEMENT CONSIDERATIONS.**

A RIM regime is proposed for Impoundment #18, similar to the plan currently implemented by IRMCD at other IRC impoundments, except that in an attempt to maximize marsh-lagoon interchange, the Southeast Cell will be left open

year-round - as long as mosquito production is not a problem from that cell. Also, by request of the Florida Medical Entomology Laboratory, the option of using this impoundment will be available as a future research site. Toward that goal, Dr. Jorge Rey has requested that culverts be placed at all interior dike breach sites. This can be accommodated as the need for it and funding allows.

- A. **CULVERT CLOSURE AND INITIAL FLOODING.** All culverts (except #5 & 6) will be closed and impoundment pumping will begin in mid-late May or after the first major rainfall causing salt-marsh mosquito egg hatching in the impoundment after April 15. Culvert #9 will be closed but culverts #5 & #6 will be left open. Typically one larvicide treatment is necessary to control mosquitoes hatching from the initial pumping. Pumping will be conducted on a need basis during the summer months to maintain the water level at approx. 1.8 ft. NGVD.
- B. **USE OF BLEED-DOWN CULVERTS.** During the closure period, the bleed-down culverts will allow for the drawdown of impoundment water and the use of some overpumping should it be deemed necessary.
- C. **MOSQUITO PRODUCTION FROM THE SOUTHEAST CELL.** If larval dipping during the summer management period shows mosquito production to become a problem, Culverts #5 & 6 will be closed and #9 will be opened allowing the Southeast Cell to become part of the flooded impoundment system. However, reasonable efforts will be made to keep the Southeast Cell open.
- D. **CESSATION OF PUMPING.** IRMCD will cease pumping IR lagoon water into Impoundment #1 by Sept. 1.
- E. **OPENING OF CULVERTS.** Using the bleed-down culverts, IRMCD will begin a slow release of impoundment water by Sept. 15 to try and avoid a large sudden release of impoundment water to the lagoon. Culvert flapgates will be opened completely when impoundment water levels equal those in the IR lagoon. However regardless of water level discrepancies, all culverts will be opened no later than Oct. 15.
- F. **ADDITIONAL CONSIDERATIONS.** IRMCD will continue to monitor rainfall, impoundment water levels, larval and adult mosquito occurrence, chemical treatments and pumping records. If an operating permit is necessary for management of this impoundment, additional monitoring as required by the permit will be conducted. In the past this has included measuring dissolved oxygen, salinity and turbidity at representative locations.

- G. **MANAGEMENT IMPLICATIONS.** The effects of opening Impoundment #18 to the lagoon will be interesting. Since the water source for summer flooding will continue to be the near-fresh canal, summer salinities in the impoundment should remain low. However, opening of the culvert to the lagoon in the fall/winter & spring should allow saline water (>20 ppt) to restore more natural salinities to the marsh during that period. The winter dry-down period should aid in impoundment revegetation. However, if dry-down is thorough, the *Ruppia* beds could suffer thus adversely affecting a food source for ducks which frequent this impoundment. But as previously mentioned, there will still remain considerable freshwater habitat nearby with the Freshwater Pond and Impoundment #19 to the north.
- H. **SUMMARY.** IRMCD believes that the proposed management changes to IR Impoundment #18, which are consistent with SOMM goals, will improve management of the area for: 1) natural resources - by establishing connection between the impoundment and lagoon and by attempting to leave part of the impoundment intertidal year-round and 2) mosquito control - by improving pumping capabilities in an impoundment with a very uneven topography. As with the other plans now being submitted by IRMCD, we look forward to working with cooperating agencies, in this case Indian River County, the St. Johns River Water Management District, the Dept. of Agriculture and Consumer Services and the Florida Medical Entomology Laboratory-University of Florida, in implementing this important project.

V. LITERATURE CITED.

- A. "A Guide to the Salt Marsh Impoundments of Florida", Jorge R. Rey & Tim Kain, University of Florida, IFAS-Florida Medical Entomology Laboratory, 1989, 447 pages.
- B. "The use of salt-marsh mosquito control impoundments as wastewater retention areas" (March 1983) Douglas B. Carlson, Mosquito News 43:1-6.
- C. "Mosquito production and hydrological capacity of southeast Florida impoundments used for wastewater retention" (March 1987) Douglas B. Carlson & Robert L. Knight, Journal of the American Mosquito Control Association 3:74-83.
- D. "Management Plan for Indian River County Impoundment #1 (Sebastian Inlet), Omega Realty Investments, Inc., July 30, 1990, 52 pages.
- E. "Salt marsh mitigation: an example of the process of balancing mosquito control, natural resource, and development interests" (1990) Peter D. O'Bryan, Douglas B. Carlson & R. Grant Gilmore, Florida Scientist 53:189-203.

FIGURE 1. IMPOUNDMENT LOCATION

INDIAN RIVER COUNTY
SOUTH

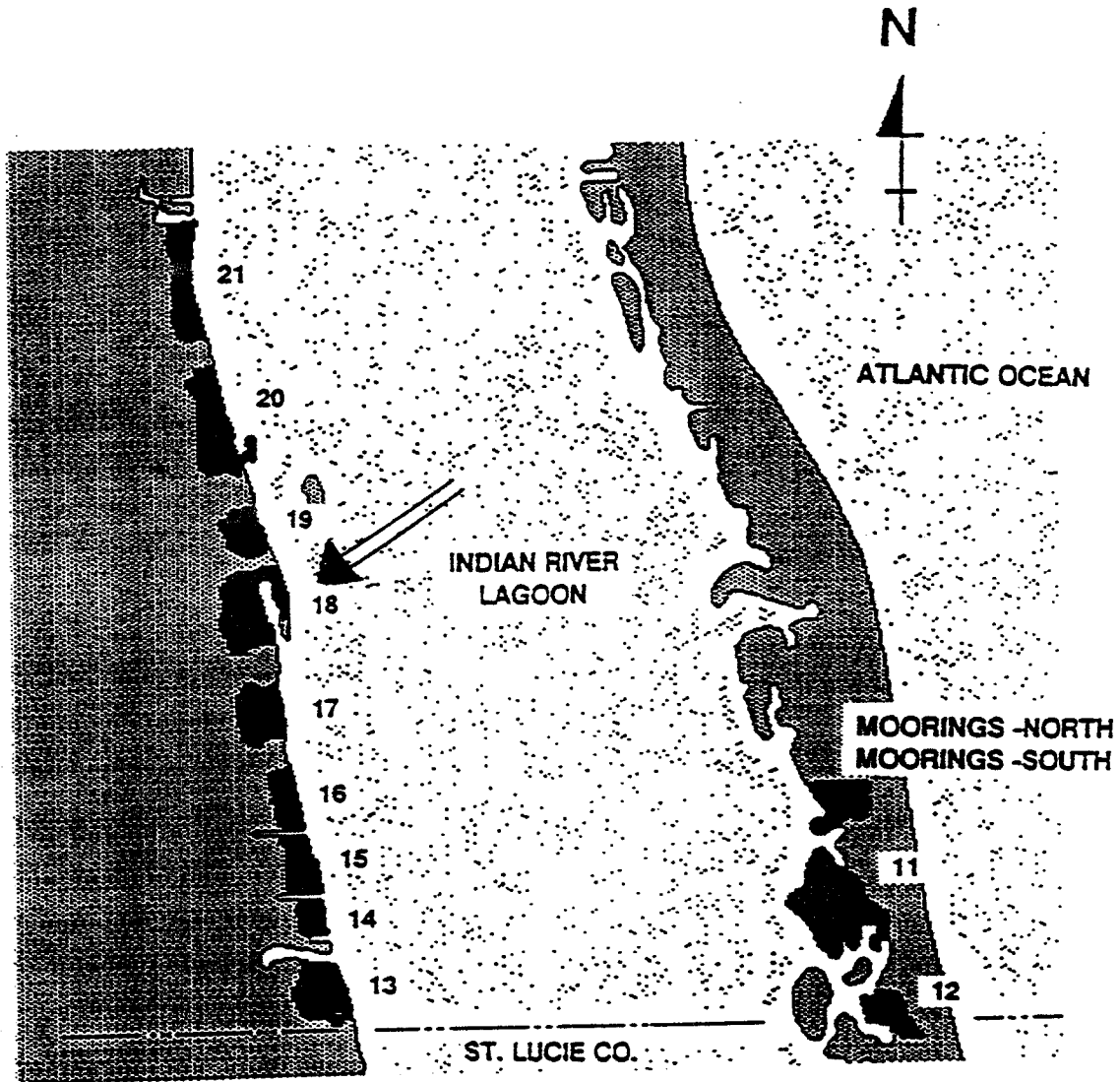

FROM: Rey/Kain Impoundment
Inventory (1989)

Scale: None

FIGURE 2. IMPOUNDMENT CONFIGURATION

18

SOUTH VISTA ROYALE

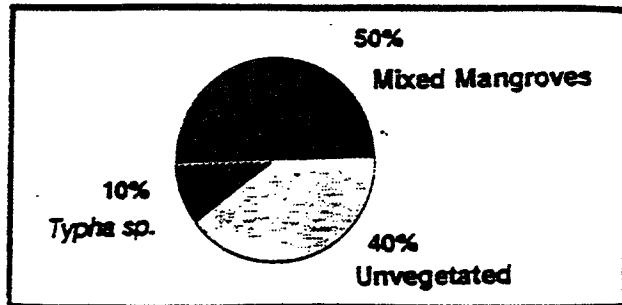
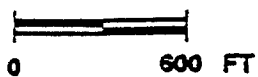
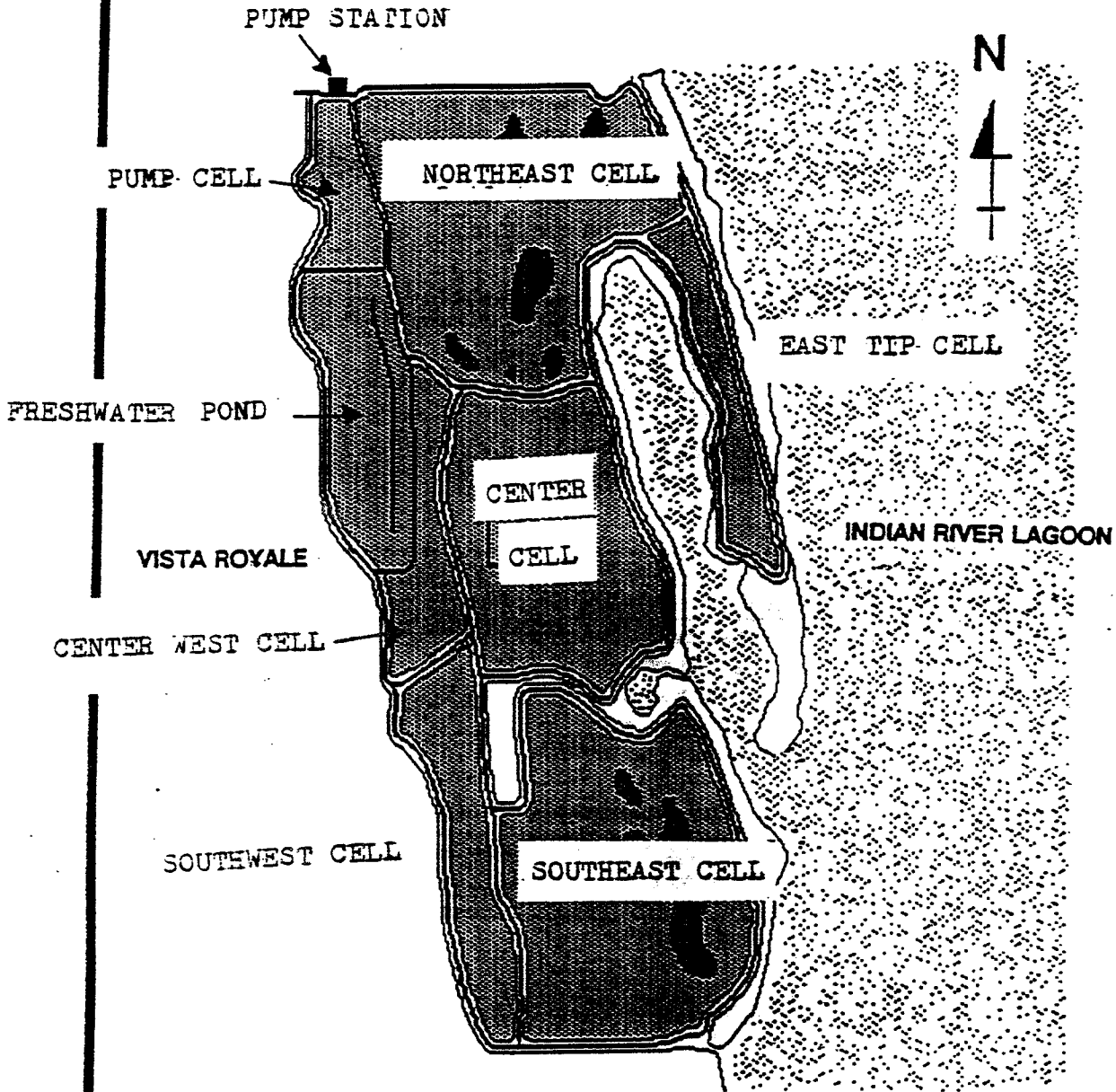

FROM: Rev/Kain 1989 Impoundment Inventory

FIGURE 3. IMPOUNDMENT DESCRIPTION

Indian River Co.

18
SOUTH VISTA ROYALE

GENERAL INFORMATION

Acres:	133
Date of Construction:	1958 & 1963
Ownership:	Private
Location (UTM):	-
Access:	Vista Royale development east of U.S. 1

IMPOUNDMENT STRUCTURES

DIKE

Condition of Dike:	Some low areas and erosion
Accessibility:	Not driveable

PUMP

Type:	Diesel
Capacity:	6000 gal/min
Operation:	Manual

CULVERTS

None

IMPOUNDMENT MANAGEMENT

Past Management Regime:	Seasonally flooded during spring and summer 1958 - 1988
Present Management Regime:	Seasonally flooded during spring and summer
Physical Parameters Monitored:	None

MOSQUITO CONTROL

Larviciding:	Infrequent, usually once per year
Larvicide Used:	Methoprene
Adulticiding:	Infrequently conducted in area near impoundment

IMPOUNDMENT VEGETATION

Mangroves - mixed	50%
<i>Typha sp.</i>	10%
Unvegetated	40%

FROM: Rev/Kain Impoundment Inventory (1989)

FIGURE 4. PROPOSED CULVERT LOCATIONS

18

SOUTH VISTA ROYALE



CULVERT #1

CULVERT #2

CULVERT #4

VISTA ROYALE

INDIAN RIV

CULVERT #8

CULVERT #3

CULVERT #7

CULVERT #5

CULVERT #9

CULVERT #6

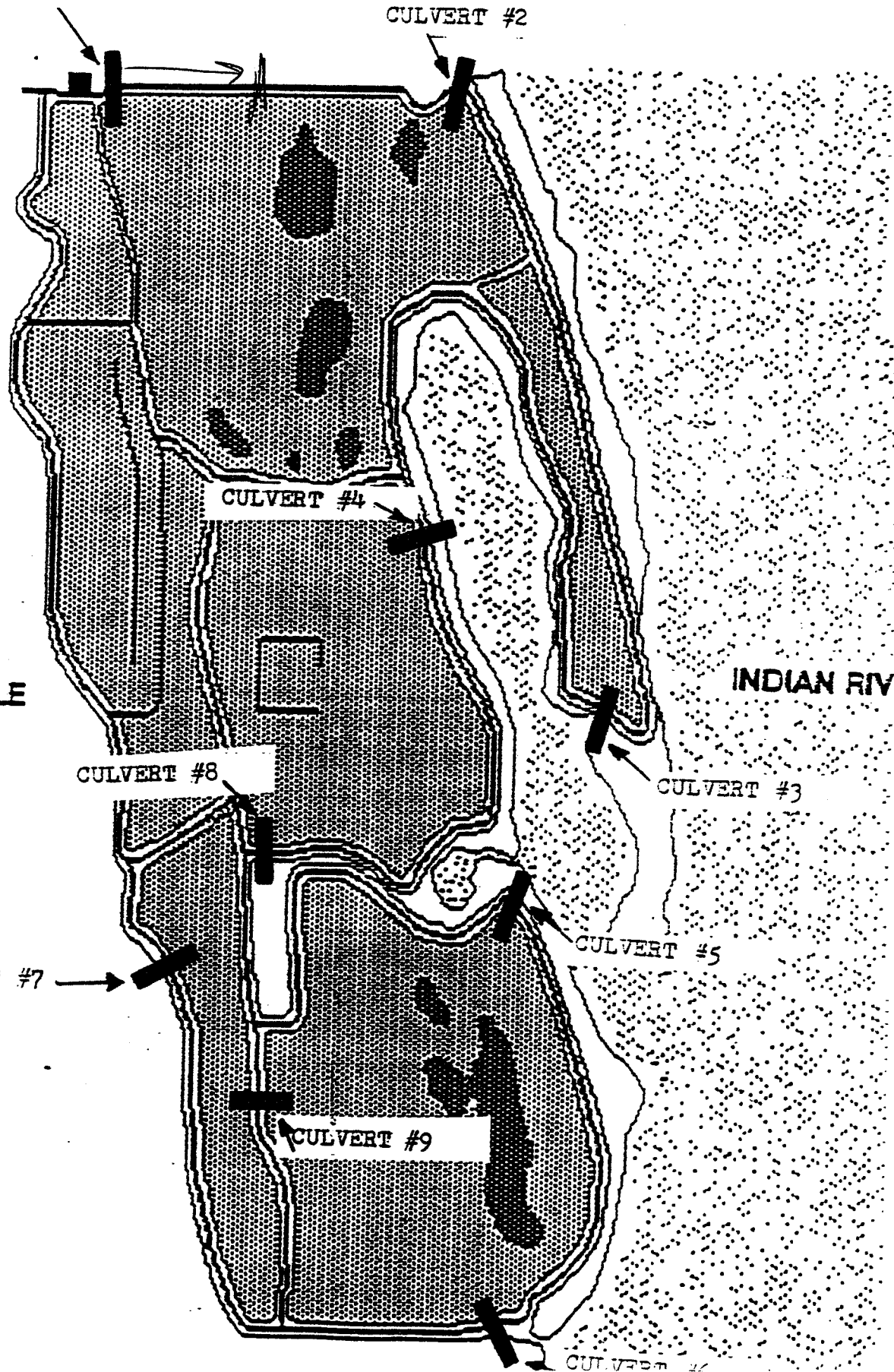

FIGURE 5. WATER QUALITY & FISH SAMPLING STATIONS.

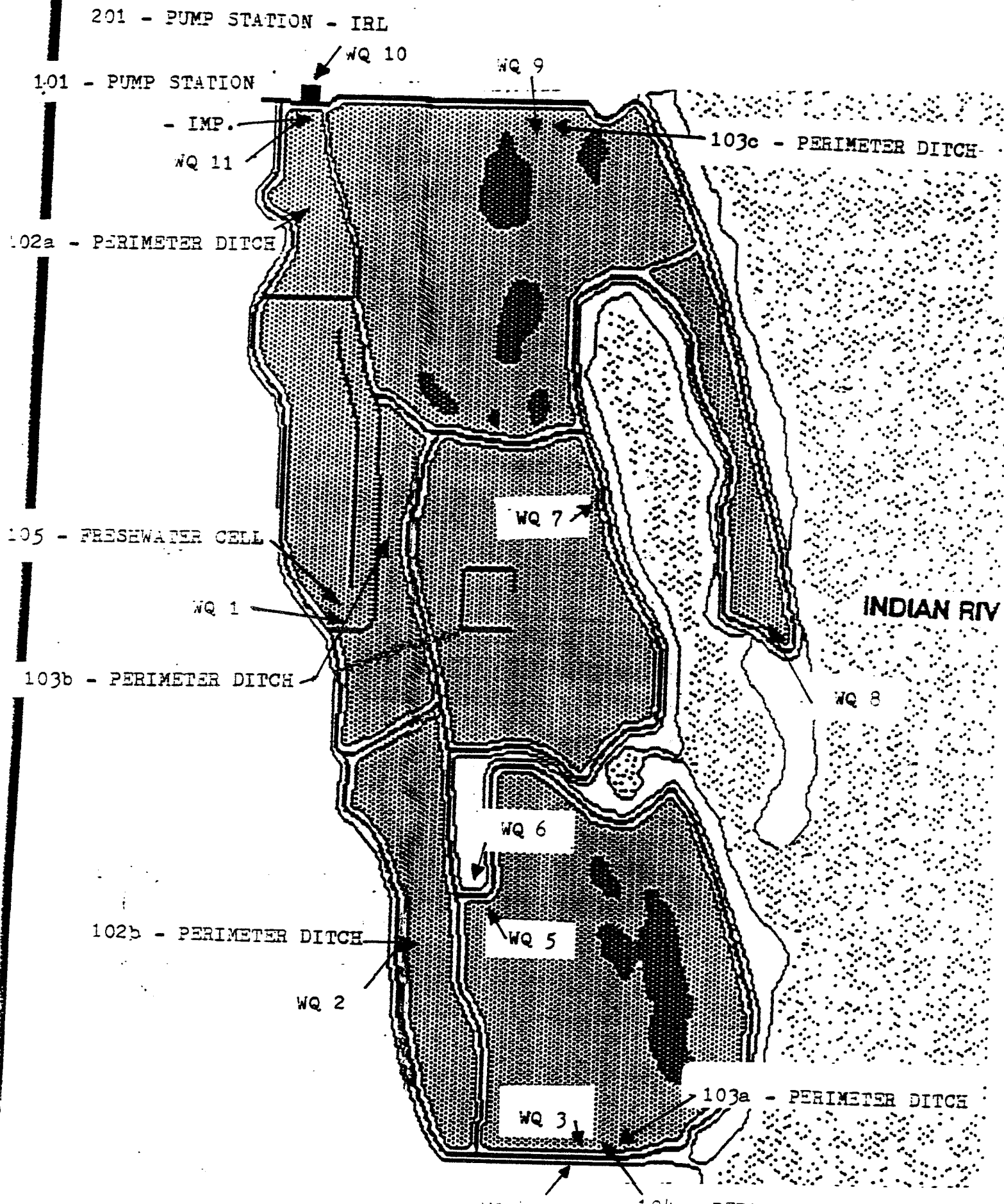
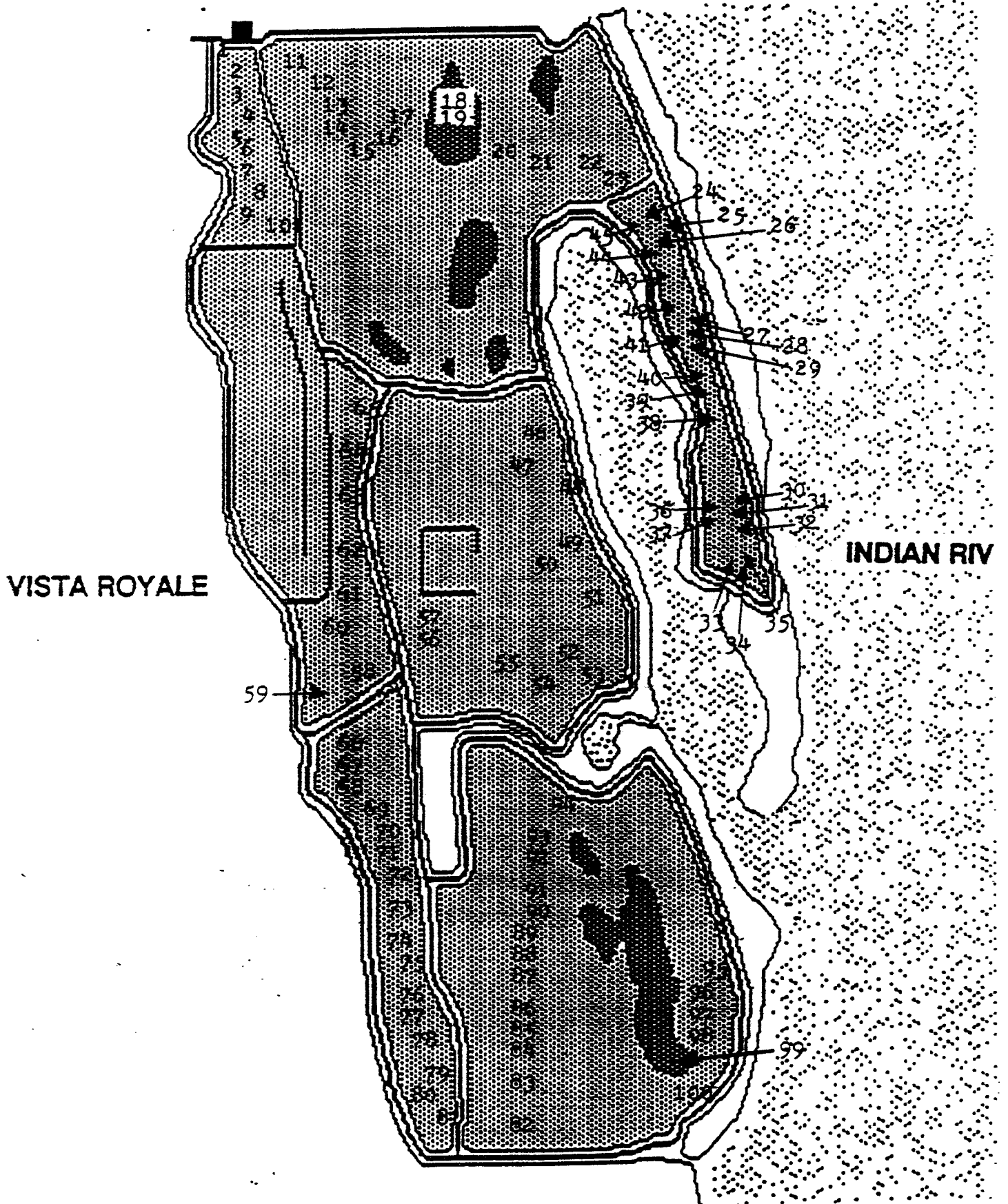

FIGURE 6. ELEVATIONS.

SOUTH VISTA ROYALE



ELEVATIONS (NGVD) AT IR IMPOUNDMENT #18 (SOUTH VISTA ROYALE)

SITE	ELEVATION	SITE	ELEVATION
1	-1.03	31	0.25
2	0.84	32	0.92
3	0.79	33	0.42
4	0.02	34	0.42
5	0.63	35	0.17
6	0.34	36	0.67
7	-0.12	37	1.13
8	-0.01	38	1.58
9	-0.04	39	1.25
10	1.50	40	1.34
11	0.54	41	1.58
12	1.60	42	1.34
13	-0.12	43	1.04
14	0.29	44	1.55
15	1.29	45	1.58
16	0.55	46	0.42
17	1.54	47	0.34
18	-1.53	48	-0.41
19	-1.32	49	1.17
20	0.71	50	1.08
21	1.13	51	-1.63
22	0.26	52	1.17
23	-1.12	53	1.00
24	0.55	54	0.42
25	-1.25	55	0.25
26	0.50	56	1.42
27	-1.49	57	0.67
28	0.03	58	1.50
29	0.50	59	1.59
30	-1.33	60	1.63

ELEVATIONS AT IR IMPOUNDMENT #18 (SOUTH VISTA ROYALE)

SITE	ELEVATION	SITE	ELEVATION
61	1.59	91	0.18
62	1.42	92	0.27
63	0.67	93	-0.06
64	0.42	94	-1.23
65	1.25	95	-0.98
66	0.36	96	-0.08
67	0.97	97	0.04
68	0.49	98	-0.10
69	1.09	99	-0.89
70	-0.79	100	0.02
71	1.51		
72	1.27		
73	-0.24		
74	1.59		
75	1.51		
76	1.59		
77	1.34		
78	1.59		
79	1.21		
80	0.59		
81	0.76		
82	-0.06		
83	0.18		
84	0.27		
85	0.18		
86	0.15		
87	-0.02		
88	0.27		
89	-0.06		
90	0.15		

FIGURE 7.
 IRL
 ELEVATIONS

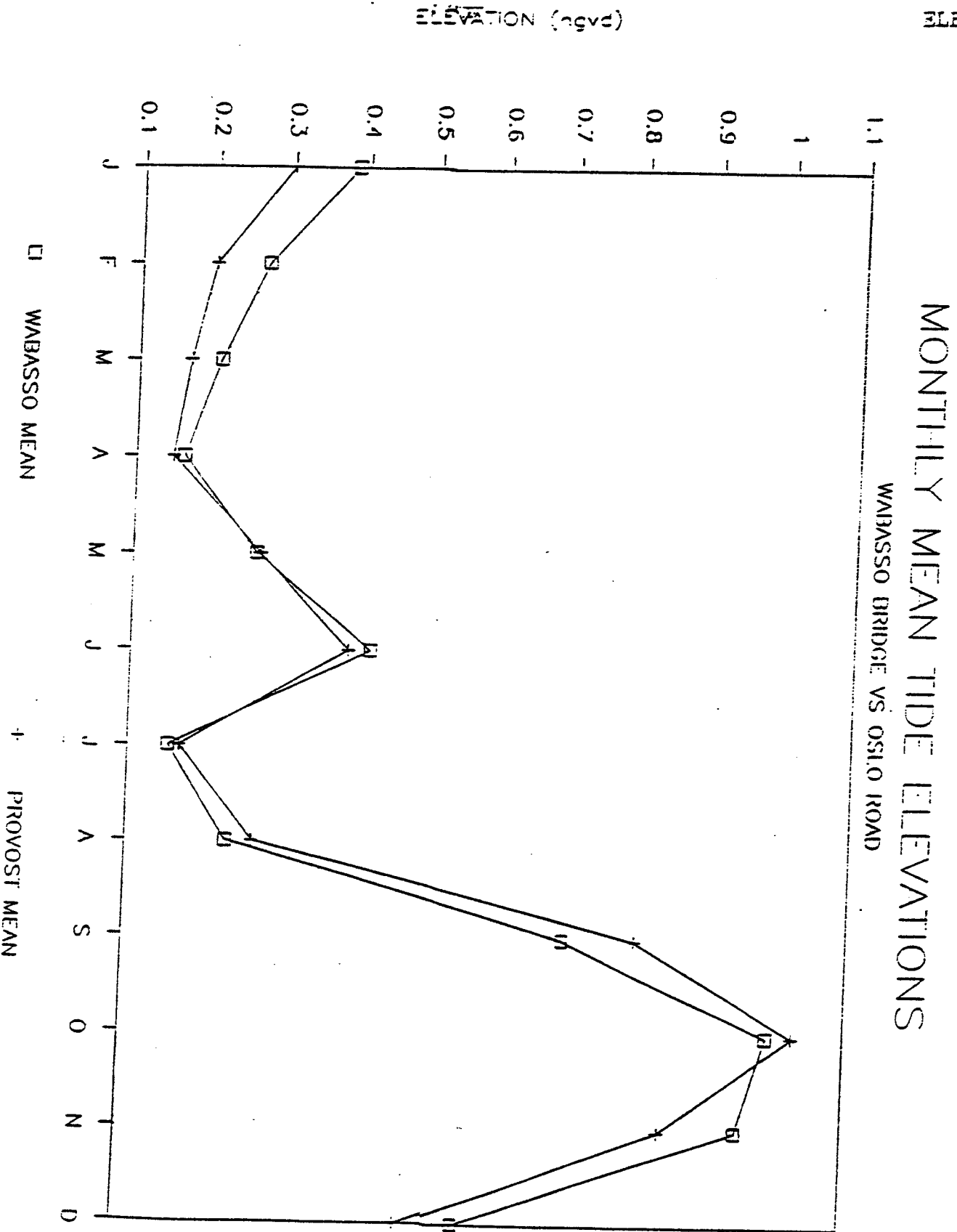

FROM: 1989 Omega Realty report on

FIGURE 8a. WATER CONTROL STRUCTURES -
CULVERTS

TOP VIEW

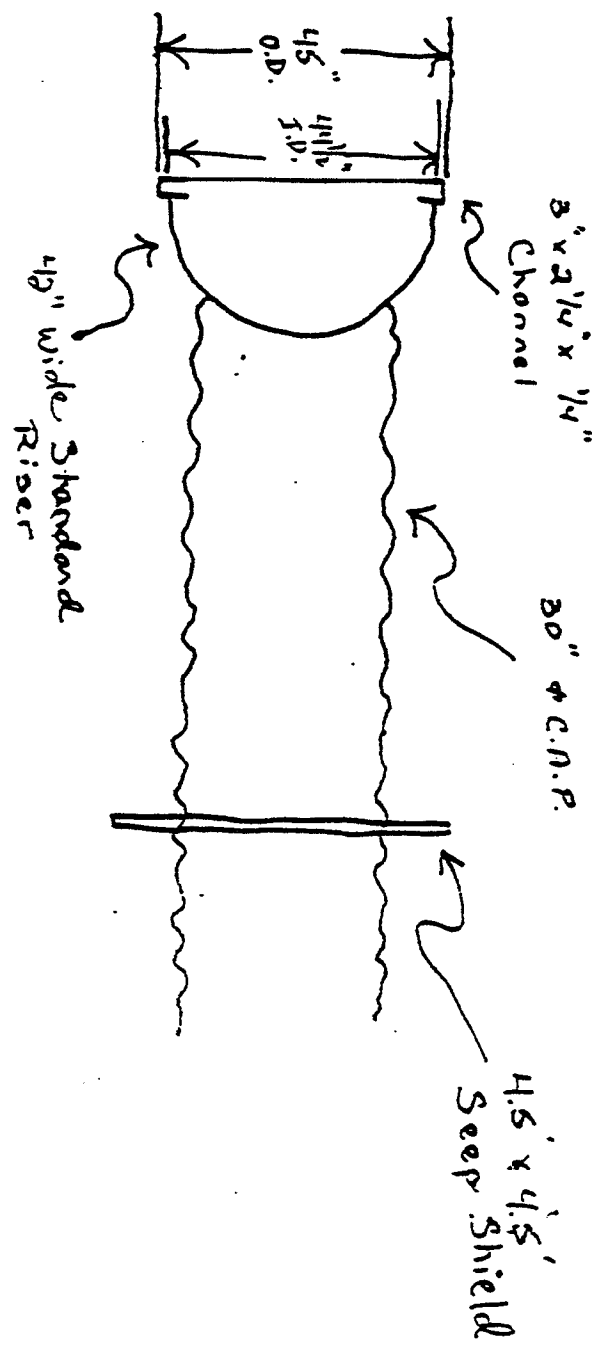

*
CULVERT INVERT
AT -1.0 FT. NGVD.

SIDE VIEW

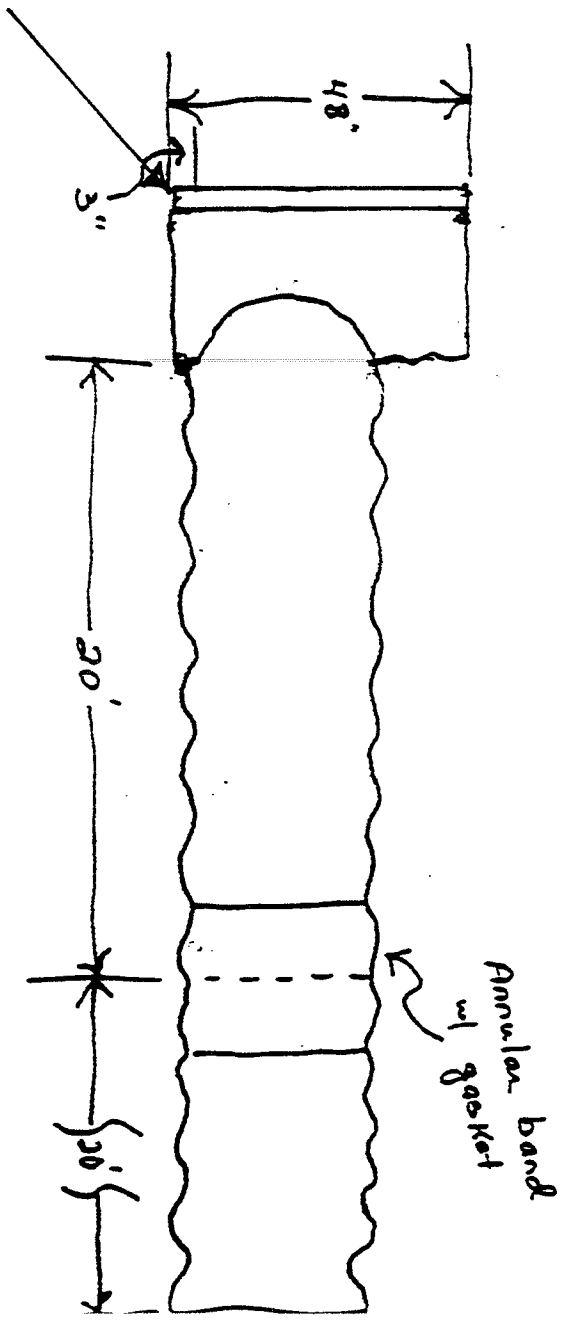

GATOR GA-40 FLAP GATE NOMENCLATURE DRAWING

FIGURE 8b. WATER CONTROL STRUCTURES -
FLAPGATE

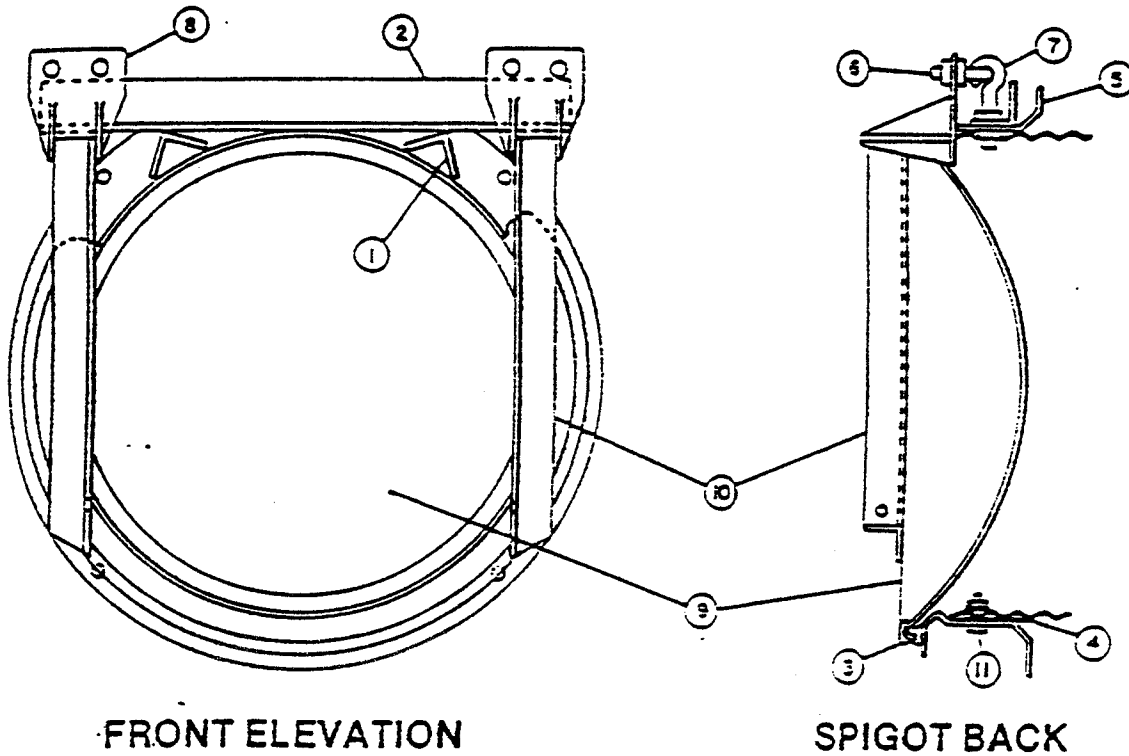

FRONT ELEVATION

SPIGOT BACK

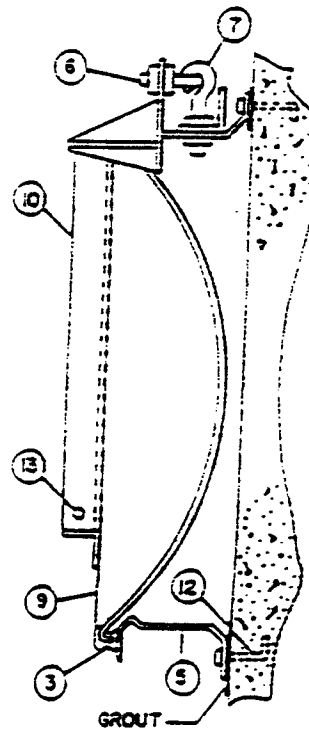

FLAT BACK

- ① HINGE SUPPORT BRACE
- ② HINGE SUPPORT BAR
- ③ SEAL
- ④ GASKET
- ⑤ RING
- ⑥ HORIZONTAL HINGE ADJUSTMENT ASSEMBLY
- ⑦ VERTICAL HINGE ADJUSTMENT ASSEMBLY
- ⑧ HINGE MOUNT
- ⑨ HEAD
- ⑩ HEAD SUPPORT BAR
- ⑪ HEX HEAD BOLT
- ⑫ ANCHOR BOLT
- ⑬ LIFTING HOLE

FIGURE 8c.

BLEED-DOWN CULVERT

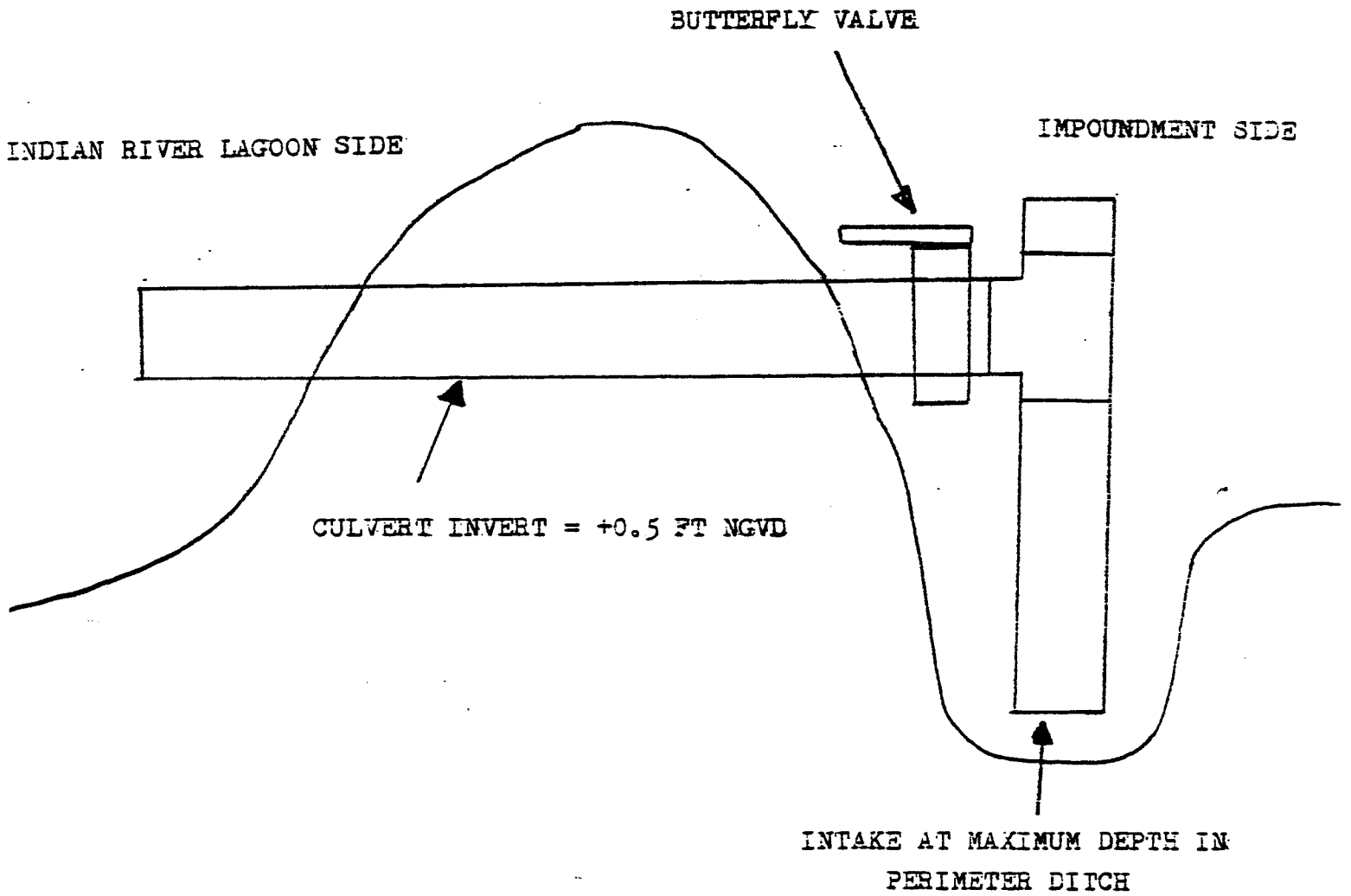
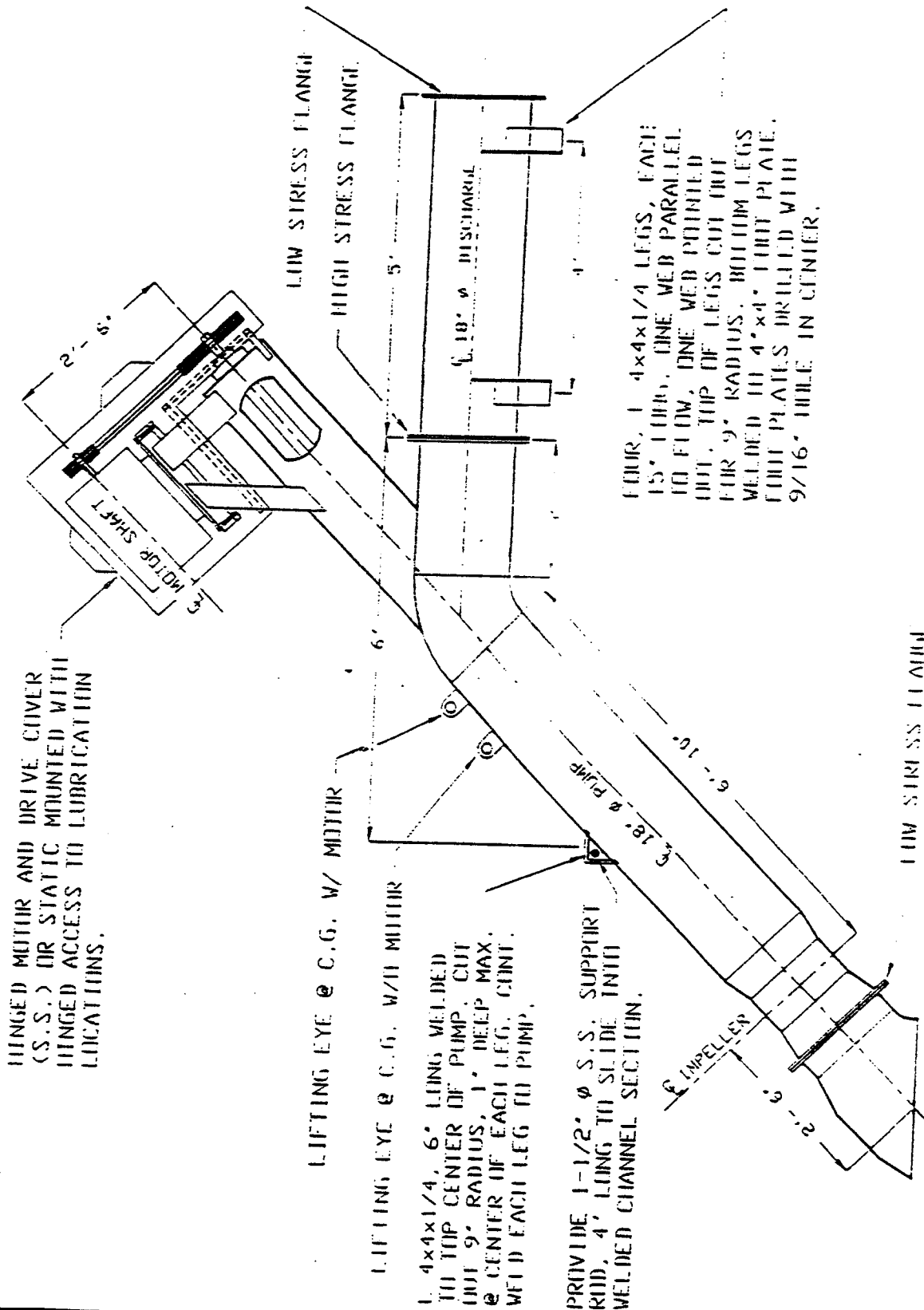

FIGURE 8 d. ELECTRIC PUMP



PUMP DESIGN CHARACTERISTICS

FIGURE 9. HISTORICAL PHOTO - 1943



TABLE 1a. DISSOLVED OXYGEN

WATER QUALITY SAMPLING - VISTA ROYALE IMPOUNDMENT

DISSOLVED OXYGEN - MORNING SAMPLES

DATE	STATION										
	1 POND	2 WEST DITCH	3 SOUTH IMP	4 SOUTH OUT	5 INTER IMP	6 INTER. RIVER	7 EAST DITCH	8 TIP	9 NORTH DITCH	10 PUMP ST OUT	11 PUMP ST IN
2/15/92	5.0	3.8	5.5	7.0	3.2	3.3	2.0	4.5	3.5	5.5	3.2
4/4/92	3.4								1.8	4.5	2.1
4/11/92	3.0	1.2	1.3	2.4							
4/25/92	1.2								1.0	3.1	1.5
MEAN	3.2	2.5	3.4	4.7	3.2	3.3	2.0	4.5	2.1	4.4	2.3
STD DEV	1.4	1.3	2.1	2.3	0.0	0.0	0.0	0.0	1.0	1.0	0.7

DISSOLVED OXYGEN - AFTERNOON SAMPLES

DATE	STATION										
	1 POND	2 WEST DITCH	3 SOUTH IMP	4 SOUTH OUT	5 INTER IMP	6 INTER. RIVER	7 EAST DITCH	8 TIP	9 NORTH DITCH	10 PUMP ST OUT	11 PUMP ST IN
1/25/92	4.3	4.2	9.0	7.5	2.6	2.9	3.2	8.0	2.8	7.0	6.3
2/14/92	7.8	7.7	8.5	8.8							
4/3/92	6.8									6.4	6.2
4/24/92	8.7								8.2	5.9	20.0
MEAN	6.9	6.0	8.8	8.2	2.6	2.9	3.2	8.0	5.5	6.4	10.8
STD DEV	1.6	1.8	0.3	0.7	0.0	0.0	0.0	0.0	2.7	0.4	6.5

TABLE 1c. TEMPERATURE

WATER QUALITY SAMPLING - VISTA ROYALE IMPOUNDMENT

TEMPERATURE - MORNING SAMPLES

DATE	STATION										
	1 POND	2 WEST DITCH	3 SOUTH IMP	4 SOUTH OUT	5 INTER IMP	6 INTER. RIVER	7 EAST DITCH	8 TIP	9 NORTH DITCH	10 PUMP STA OUT	11 PUMP STA IN
2/15/92	19.0	19.0	21.0	21.5	20.5	20.5	20.5	20.5	20.5	20.5	19
4/4/92	17.5								18	19.5	19
4/11/92	25.0	24.0	23.5	23.5							
4/25/92	25.0								26	27	25
MEAN	21.6	21.5	22.3	22.5	20.5	20.5	20.5	20.5	21.5	22.3	21.0
STD DEV	3.4	2.5	1.3	1.0	0.0	0.0	0.0	0.0	3.3	3.3	2.8

TEMPERATURE - AFTERNOON SAMPLES

DATE	STATION										
	1 POND	2 WEST DITCH	3 SOUTH IMP	4 SOUTH OUT	5 INTER IMP	6 INTER. RIVER	7 EAST DITCH	8 TIP	9 NORTH DITCH	10 PUMP STA OUT	11 PUMP STA IN
1/25/92	12.5	13.0	12.0	11.0	12.0	11.0	11.0	12.0	14.0	15.0	15.0
2/14/92	21.5	20.0	22.0	23.0							
4/3/92	21.5									22.0	21.5
4/24/92	30.0								30.0	29.0	28.5
MEAN	21.4	16.5	17.0	17.0	12.0	11.0	11.0	12.0	22.0	22.0	21.7
STD DEV	6.2	3.5	5.0	6.0	0.0	0.0	0.0	0.0	8.0	5.7	5.5

TABLE 2a.

FISH SAMPLING - VISTA ROYALE IMPOUNDMENT

STATION 18 - 101 PUMP STATION IMPOUNDMENT
CAST NET, PULL SEINE

	SAMPLING DATES / NUMBER (SIZE RANGE (mm))			TOTAL / TOTAL RANGE
	February 15	April 4 *	April 25	
<i>Cyprinodon variegatus</i> (sheepshead minnow)		42 (30 - 45) *		42 (30 - 45)
<i>Domitator maculatus</i> (fat sleeper)		36 (45 - 110) *	2 (100 - 105)	38 (45 - 110)
<i>Eucinostomus</i> spp. (mojarra)		95		1 (95)
<i>Fundulus confluentus</i> (marsh killifish)		12 (47 - 70) *		12 (47 - 70)
<i>Gambusia holbrooki</i> (mosquito fish)		7290 (12 - 33) *		7290 (12 - 33)
<i>Lucania parva</i> (rainwater killifish)		6 (20 - 29) *		6 (20 - 29)
<i>Megalops atlanticus</i> (tarpon)	1 (135)	5 (105 - 290)		6 (135 - 290)
<i>Mugil cephalus</i> (striped mullet)		1 (28)		1 (28)
<i>Palaemonetes</i> spp. (grass shrimp)		5064 (12 - 28) *		5064 (12 - 28)
<i>Poecilia latipinna</i> (sailfin molly)		1128 (26 - 50) *		1128 (26 - 50)

* denotes total numbers determined by aliquot

FISH SAMPLING - VISTA ROYALE IMPOUNDMENT

STATION 18 - 201 PUMP STATION RIVER

CAST NET

	SAMPLING DATES / NUMBER (SIZE RANGE (mm))			TOTAL / TOTAL RANGE
	February 15	April 4	April 25	
<i>Megalops atlanticus</i> (tarpon)	1 (310)	1 (245)		2 (245 - 310)
<i>Mugil cephalus</i> (striped mullet)	1 (250)	5 (210 - 260)		6 (210 - 260)

TABLE 2b.

FISH SAMPLING - VISTA ROYALE IMPOUNDMENT

STATION 18 - 102 PERIMETER DITCH
BOX TRAP

	SAMPLING DATES / NUMBER (SIZE RANGE (mm))				TOTAL / TOTAL RANGE
	February 15	April 4	April 11	April 25	
<i>Callinectes sapidus</i> (blue crab)		2 (120 - 140)			2 (120 - 140)
<i>Cyprinodon variegatus</i> (sheepshead minnow)	2 (24 - 39)	5 (16 - 35)	20 (24 - 44)	9 (12 - 47)	36 (12 - 47)
<i>Dormitator maculatus</i> (fat sleeper)			1 (48)	1 (42)	2 (42 - 48)
<i>Fundulus confluentus</i> (marsh killifish)	1 (45)		2 (45 - 70)	1 (63)	4 (45 - 70)
<i>Fundulus grandis</i> (gulf killifish)	1 (54)		1 (59)		2 (54 - 59)
<i>Gambusia holbrooki</i> (mosquito fish)	60 (17 - 30)	90 (15 - 35)	712 (17 - 37)	26 (13 - 25)	888 (13 - 37)
<i>Lucania parva</i> (rainwater killifish)	127 (20 - 35)	32 (17 - 32)	66 (23 - 26)	34 (15 - 30)	259 (15 - 35)
<i>Palaemonetes</i> spp. (grass shrimp)	40 (16 - 30)	42 (16 - 30)	78 (12 - 26)	33 (15 - 27)	193 (12 - 30)
<i>Poecilia latipinna</i> (sailfin molly)	6 (20 - 40)	26 (20 - 35)	66 (25 - 40)	33 (22 - 44)	131 (20 - 44)
Pollywog	1 (50)				1 (50)

FISH SAMPLING - VISTA ROYALE IMPOUNDMENT

STATION 18 - 103 PERIMETER DITCH - ALL SITES

HEART TRAP

	SAMPLING DATES / NUMBER (SIZE RANGE (mm))			TOTAL / TOTAL RANGE
	February 15	April 4	April 25	
<i>Cyprinodon variegatus</i> (sheepshead minnow)	1 (20)			1 (20)
<i>Dormitator maculatus</i> (fat sleeper)		5 (36 - 66)	1 (85)	6 (36 - 85)
<i>Fundulus confluentus</i> (marsh killifish)	2 (25 - 35)			2 (25 - 35)
<i>Gambusia holbrooki</i> (mosquito fish)	9 (15 - 30)	4 (15 - 23)	15 (15 - 20)	28 (15 - 30)
<i>Lucania parva</i> (rainwater killifish)	27 (14 - 31)	1 (19)	2 (22 - 25)	30 (14 - 31)
<i>Palaemonetes</i> spp. (grass shrimp)	66 (10 - 31)	158 (15 - 31)	161 (13 - 30)	385 (10 - 31)
<i>Poecilia latipinna</i> (sailfin molly)	8 (15 - 27)	8 (17 - 40)	1 (19)	17 (15 - 40)

FISH SAMPLING - VISTA ROYALE IMPOUNDMENT

TABLE 2c.

STATION 18 - 104 PERIMETER DITCH SOUTH

PULL SEINE

SAMPLING DATES / NUMBER (SIZE RANGE {mm})

TOTAL / TOTAL RANGE

	February 15 (*)	April 11 (1)	
<i>Callinectes sapidus</i> (blue crab)	2 (155 - 160)	(100 - 140)	2+ (100 - 160)
<i>Cyprinodon variegatus</i> (sheepshead minnow)	50 (17 - 35)	(13 - 45)	50+ (13 - 45)
<i>Fundulus grandis</i> (gulf killifish)		(41)	1 (41)
<i>Gambusia holbrooki</i> (mosquito fish)	1000 (19 - 30)	(12 - 32)	1000+ (12 - 32)
<i>Lucania parva</i> (rainwater killifish)	400 (20 - 28)	(19 - 33)	400+ (19 - 33)
<i>Palaemonetes</i> spp. (grass shrimp)		(16 - 25)	2+ (16 - 25)
<i>Poecilia latipinna</i> (sailfin molly)	50 (17 - 25)	(15 - 25)	50+ (15 - 25)

(*) = total numbers determined by aliquot
except for *Callinectes sapidus*

(1) = quantitative only, species and range determined
no species numbers recorded

FISH SAMPLING - VISTA ROYALE IMPOUNDMENT

STATION 18 - 105 FRESHWATER CELL

HEART TRAP / PULL SEINE

SAMPLING DATES / NUMBER (SIZE RANGE {mm})

TOTAL / TOTAL RANGE

	April 11 (heart trap)	April 25 (heart trap)	April 25 * (pull seine)	
<i>Gambusia holbrooki</i> (mosquito fish)	OBS.	5 (14 - 37)	(10 - 36)	5+ (10 - 37)
<i>Heterandria formosa</i> (least killifish)		1 (17)		1 (17)
<i>Lopomis macrochirus</i> (bluegill)	OBS.	1 (130)	(12 - 18)	1+ (12 - 130)
<i>Lucania parva</i> (rainwater killifish)	5 (28 - 31)	1 (32)	(20 - 31)	6+ (20 - 32)
<i>Palaemonetes</i> spp. (grass shrimp)		2 (25 - 29)	(19 - 31)	2+ (19 - 31)

* = Species sampling only, no numbers recorded

TABLE 3. IMPOUNDMENT #18 AERIAL LARVICIDING DATA.

YEAR	# TREATMENTS	ACRES TREATED	#'S ALTOSAND
1977	NA	1120	NA
1978	NA	85	NA
1979	0	0	0
1980	0	0	0
1981	NA	191	NA
1982	5	111	888
1983	2	60	480
1984	1	60	480
1985	1	47	376
1986	1	50	400
1987	1	133	1064
1988	0	0	0
1989	1	133	1064
1990	0	0	0
1991	0	0	0
MEAN 84-91	0.6	52.8	423

APPROXIMATE LOCATION OF ARCHAEOLOGICAL SITES
<div style="display: flex; justify-content: space-around;"> <div style="text-align: center;"> <p>836</p> <p>BIDLINGMAYER SITE</p> </div> <div style="text-align: center;"> <p>837</p> <p>IFAS SITE</p> </div> <div style="text-align: center;"> <p>838</p> <p>CRAWFORD SITE</p> </div> </div>

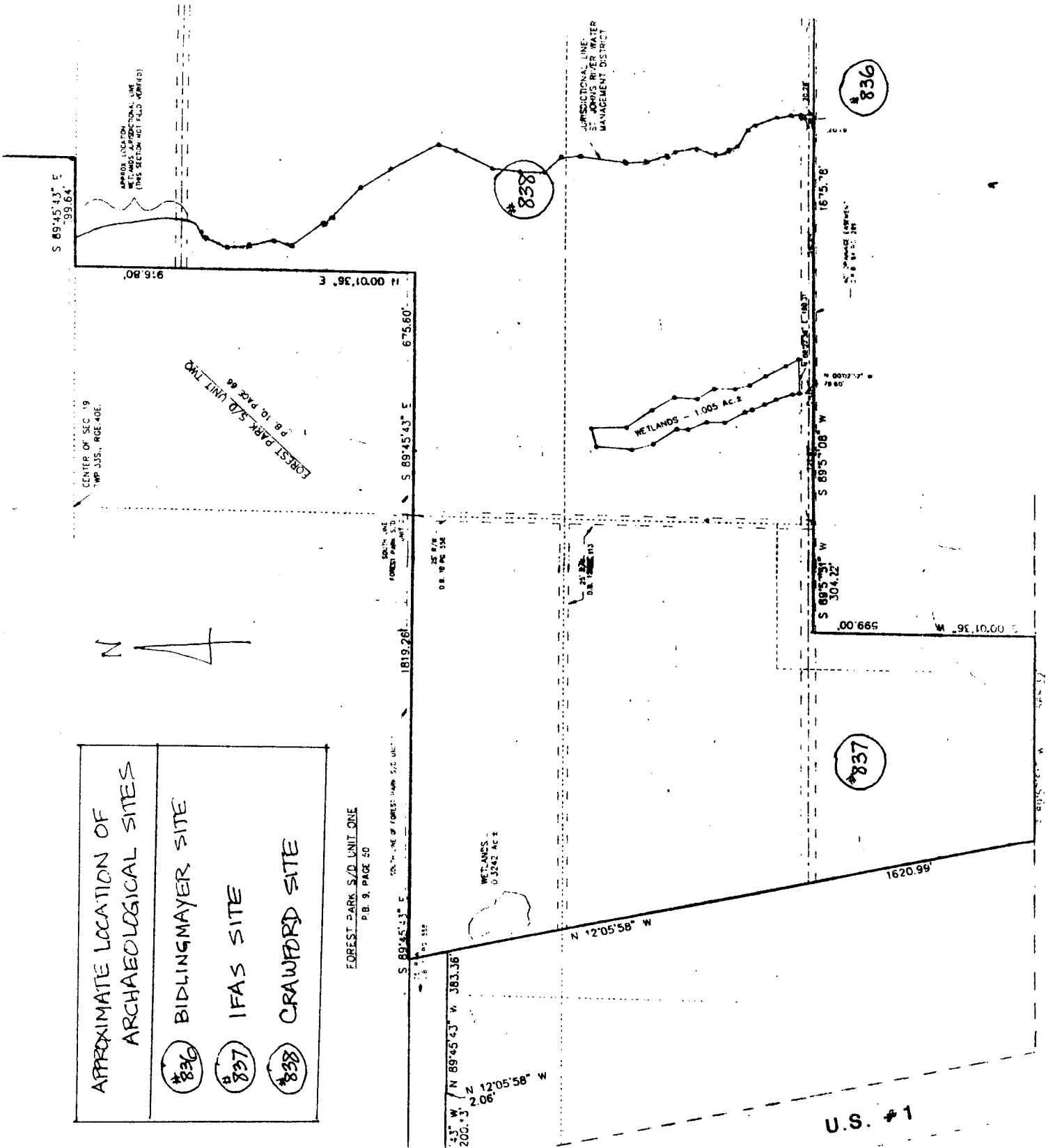
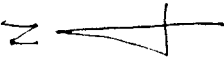

U.S. #1



Lagoon Greenway Plan

Purpose of the Lagoon Greenway

The purpose of the Indian River “Lagoon Greenway” is to create a trail system for public access to the Indian River Lagoon between the South Relief Canal and the 17th Street Bridge for a variety of recreational and educational uses.

Overview of Greenway Plan

The Lagoon Greenway Plan is the means to bring the Lagoon Greenway to reality. Based on the goals set forth below, the Plan encompasses three major elements:

1. Resource inventory and an analysis of the opportunities and challenges associated with the establishment of a greenway trail system and related facilities;
2. Layout and cost estimates for proposed phased trail/elevated walk segments, parking areas, access points and amenities; and
3. Recommendations for an organizational structure, timeline and possible funding sources for the Lagoon Greenway’s development and long-term management.

Lagoon Greenway Goals

The following set of goals and strategies for the Lagoon Greenway are derived from discussions among involved local and state agency staff, members of the Lagoon Greenway Advisory Committee and Indian River Land Trust board and staff.

1. Create a continuous set of pathways for non-motorized use through the upland and lowland areas along the Indian River Lagoon with ample public access as appropriate.
 - a. Make use of existing unimproved mosquito district impoundment roads
 - b. Provide a diversity of connected pathways and boardwalks
 - c. Create safe direct access from adjacent neighborhoods and public properties
2. Provide for a diversity of recreational and educational opportunities within the Greenway Planning Area as appropriate for the residents and visitors of Indian River County. Recreational activities should include:
 - a) bicycling, jogging and walking; b) lagoon viewing; c) canoe/kayak access; d) fishing; e) wildlife observation & study; and f) fitness.

3. Continue to protect and conserve the natural resources of the Lagoon and adjoining wetland and upland habitats.

- a. establish a schedule for trail and wetland clean ups
- b. develop goals & strategies for long-term abatement of invasive plants
- c. coordinate efforts for other improvements to the natural resources

4. Establish interpretive facilities (and corresponding programs) for educating the public of the significance of the Greenway's local natural and historic resources and the need for their management. Interpretive facilities should include: a) trail and interpretive signage; b) trailhead kiosks and observation decks to accommodate individuals and/or groups; c) distribution points for educational materials; and d) wildlife blinds (viewing areas).

Topics to consider for interpretation include: a) interaction of the native mangroves with the IR Lagoon; b) importance of Greenway area for mosquito control; c) wetlands as important absorbers of excess rainwater; and d) people's historic and present interaction with IR Lagoon.

Greenway Background and Initiative

During the 1990's, several properties along the Indian River Lagoon south of the 17th Street Bridge in Vero Beach were protected from development by a combination of outright purchases or with development mitigation easements for projects along Indian River Boulevard. They were protected primarily to conserve the native wetland habitat and buffer the shoreline of the Lagoon. These properties which are in both public and private ownership are made up primarily of mangrove swamps ringed by impoundment roads managed by the Indian River County Mosquito Control District for minimizing the mosquito populations of eastern Indian River County.

The mangrove swamps along the Indian River Lagoon are very important wetlands for a variety of reasons. They are an important nursery for spawning and early growth stages of a variety of native fish species. They provide an important natural protection during tropical storms to prevent erosion and destruction of shoreline and nearby structures from wave action, wind and flooding. Lastly, they harbor a large variety of native plants and wildlife important for maintaining a healthy ecosystem.

In 2007, a local citizens group and the Indian River Land Trust, which owns one of these properties along the Lagoon, established the idea for an Indian River Lagoon Greenway situated between the South Relief Canal and the 17th Street Bridge. Working with the citizens group, now the Lagoon Greenway Advisory Committee, together with staff from the Mosquito Control District, the Florida Inland Navigation District, and the Indian River County Environmental Lands Program, IRLT has set forth this plan for the Indian River "Lagoon Greenway."

Supporting Greenway Maps

The four supporting maps for the Lagoon Greenway Plan are as follows:

Map #1 – Location Overview

This map indicates the Greenway Planning Area in relation to surrounding community features and neighborhoods.

Map #2 – Greenway Aerial

This map is an aerial photograph marking the total potential Greenway Planning Area.

Map #3 – Existing Greenway Resources

The Existing Greenway Resources map illustrates the types and location of existing features that create opportunities for development of the Lagoon Greenway.

Map #4 - Greenway Plan

The Greenway Plan map depicts a series of trails and facilities to be constructed in phases during the development of the Lagoon Greenway.

Summary of Key Maps

The following is a description of the features found on Map #3 (Existing Greenway Resources) and Map #4 (Greenway Plan).

Existing Greenway Resources (see Map #3)

An inventory of existing Greenway resources, with a map showing the types and location of existing features, is critical for identifying and analyzing the opportunities for development of the Lagoon Greenway. The inventory is important for understanding the setting of the area and the physical relationship among these features. The map, which encompasses both the Greenway Planning Area and surrounding properties, identifies the following features.

1. Existing Prominent Land & Water Features

Indian River Lagoon, canals/ditches, impounded wetlands, earthen impoundment roads, Lagoon access and viewpoints (4)

2. Nearby Significant Historic, Cultural and Recreation Sites

Public garden (McKee Botanical), public golf course.

3. Existing Land Ownership

Property ownership (see below), municipal highways/roads.

The total Greenway Planning Area properties under consideration for potential development of the Lagoon Greenway, from north to south, are as follows:

Hoffman =	35 acres
Florida Navigation Inland District =	53 acres
Indian River County, et al =	38 acres
River Park Place, LP =	30 acres
Indian River Land Trust =	<u>66 acres</u>
TOTAL ACREAGE =	222 acres

*Note: Over 80% of the above property acreages, not include existing mosquito control impoundment roads, were identified as either lowland or river lands by the IR County Property Appraiser.



North



Graphic Scale

Legend

- Trail/Educational Kiosk
- Public Places
- Parking
- Picnic Site
- Signage
- Boardwalk
- Greenway Planning Area
- Viewpoints
- Upland Trail
- Fencing
- Impoundment Roads
- Wetlands

